



**Meeting of the Valley Clean Energy Alliance  
Board of Directors  
Thursday, February 13, 2020 at 5:30 p.m.  
City of Davis Community Chambers  
23 Russell Boulevard, Davis, CA 95616**

Meetings are accessible to people with disabilities. Individuals who need special assistance or a disability-related modification or accommodation to participate in this meeting, or who have a disability and wish to request an alternative format for the meeting materials, should contact Alisa Lembke, VCEA Board Clerk/Administrative Analyst, at least two (2) working days before the meeting at (530) 446-2754 or [Alisa.Lembke@valleycleanenergy.org](mailto:Alisa.Lembke@valleycleanenergy.org).

If you have anything that you wish to be distributed to the Board and included in the official record, please hand it to a member of VCEA staff who will distribute the information to the Board members and other staff.

Please note that the numerical order of items is for convenience of reference. Items may be taken out of order on the request of any Board member with the concurrence of the Board. Staff recommendations are advisory to the Board. The Board may take any action it deems appropriate on any item on the agenda even if it varies from the staff recommendation.

**Board Members:** Don Saylor (Chair/Yolo County), Dan Carson (Vice Chair/City of Davis), Tom Stallard (City of Woodland), Gary Sandy (Yolo County), Lucas Frerichs (City of Davis), Angel Barajas (City of Woodland), Wade Cowan (City of Winters), and Jesse Loren (City of Winters)

**Associate Members:** Christopher Cabaldon (City of West Sacramento), Beverly Sandeen (City of West Sacramento)

**5:30 p.m. Call to Order**

- 1. Welcome**
- 2. Approval of Agenda**
- 3. Public Comment:** This item is reserved for persons wishing to address the Board on any VCEA-related matters that are not otherwise on this meeting agenda. Public comments on matters listed on the agenda shall be heard at the time the matter is called. As with all public comment, members of the public who wish to address the Board are customarily limited to two minutes per speaker, but an extension can be provided at the discretion of the Chair.

**CLOSED SESSION**

- 4. A. VCE Board including Associate Board Members: Conference with Legal Counsel – Existing Litigation (Paragraph (1) of subdivision (d) of Section 54956.9)**

Name of Cases:

(1) In re PG&E Corporation, Debtor; Chapter 11; US Bankruptcy Court, Northern District of California San Francisco Division, Case No. 19-30088(DM) and Case No. 19-30089(DM)

(2) Investigation 19-09-016 related to the consideration of the Ratemaking and other Implications of a Proposed Plan for Resolution of Voluntary Cases filed by PGE pursuant to the Bankruptcy Code, before the California Public Utilities Commission.

- (3) Safety Order Instituting Investigation (O.I.I.) and Rulemaking
- i. O. I. I. 15-08-019 ( G&E Safety culture); Order Instituting Investigation on the Commission’s Own Motion to Determine Whether Pacific Gas and Electric Company and PG&E Corporation’s Organizational Culture and Governance Prioritize Safety.
  - ii. O. I. I. 19-06-015 (PG&E Safety Culture and Penalties for 2017 Fires); Order Instituting Investigation on the Commission’s Own Motion into the Maintenance, Operations and Practices of Pacific Gas and Electric Company (U39E) with Respect to its Electric Facilities; and Order to Show Cause Why the Commission Should not Impose Penalties and/or Other Remedies for the Role PG&E’s Electrical Facilities had in Igniting Fires in its Service Territory in 2017
  - iii. R. 18-12-005 (PSPS Rulemaking); Order Instituting Rulemaking to Examine Electric Utility De-Energization of Power Lines in Dangerous Conditions.

**B. Public Employee Performance Evaluation (Government Code Section 54957)  
Position Title: Interim General Manager**

**CONSENT AGENDA**

- 5. Approve January 9, 2020 Board Meeting Minutes.
- 6. Receive 2020 Long Range Calendar.
- 7. Receive Financial Update – December 31, 2019 (unaudited) financial statement.
- 8. Receive February 6, 2020 Regulatory Update provided by Keyes & Fox.
- 9. Receive Legislative Update and approve support of the following legislation:
  - a. AB 1567 (Aguiar-Curry) – Creation of a scoping plan for the State to meet its organic waste goals, including use of bio-energy resources.
  - b. SB 378 (Wiener) Addressing Public Safety Power Shut-off (PSPS) events.
  - c. SB 804 (Weiner) Extend the use of rate reduction bonds to local power agencies.
  - d. SB 917 (Weiner) PG&E Public Take-over Plan.
- 10. Receive February 6, 2020 Customer Enrollment Update.
- 11. Receive Community Advisory Committee January 23, 2020 Meeting Summary.
- 12. Approve contract amendment to extend the contract of Valley Clean Energy regulatory counsel Keyes & Fox. (Action)
- 13. Approve contract amendment to increase the rate for Valley Clean Energy co-general counsel Best, Best & Krieger. (Action)
- 14. Ratify Amendment 14 to Task Order 3 to the Sacramento Municipal Utility District (SMUD) agreement extending credit support services and approve Amendment 15 to Task Order 4 to SMUD agreement removing Proxy Power Director obligation. (Action)
- 15. Approve change to the employee medical benefits offered by Valley Clean Energy and update those changes in the Employee Handbook. (Action)
- 16. Approve revision to Item #4 of the February 13, 2020 Net Energy Metering (NEM) Policy.
- 17. Approve Valley Clean Energy Sponsorship Program Guidelines and authorize staff to adjust guidelines as needed. (Action)

**REGULAR AGENDA**

- 18. Recognize service of past Chair (Gerry Braun) and Vice-Chair (Christine Shewmaker) of the Valley Clean Energy Community Advisory Committee. (Ceremonial)
- 19. Approve Power Purchase Agreement between Valley Clean Energy and Aquamarine Westside LLC for the procurement of energy from a 50 megawatt share of the 250 megawatt Aquamarine Solar Project under development by Westland Solar Park, located in Kings County, California. (Action)
- 20. Introduce planning process for the development of a strategic plan for Valley Clean Energy and adopt a process timeline. (Action)

21. **Approve Valley Clean Energy's Policy regarding potential PG&E allocation of Greenhouse Gas (GHG)-free (Large Hydro and Nuclear) resources to Community Choice Aggregators. (Action)**
22. **Update on Power Charge Indifference Adjustment (PCIA) and Energy Resource Recovery Account (ERRA). (Informational)**
23. **Update on Sacramento Council of Governments Electric Vehicle Charging Infrastructure Grant (Informational)**
24. **Status update and next steps on the potential acquisition of PG&E's local electricity distribution system. (Informational)**
25. **Board Member and Staff Announcements:** Action items and reports from members of the Board, including announcements, AB1234 reporting of meetings attended by Board Members of VCEA expense, questions to be referred to staff, future agenda items, and reports on meetings and information which would be of interest to the Board or the public.
26. **Adjournment**

**The next VCE Board meeting is scheduled for Thursday, March 13, 2020 at 5:30 p.m. at the City of Woodland Council Chambers, 300 1<sup>st</sup> Street, Woodland, CA 95695.**

Public records that relate to any item on the open session agenda for a regular board meeting are available for public inspection. Those records that are distributed less than 72 hours prior to the meeting are available for public inspection at the same time they are distributed to all members, or a majority of the members of the Board. VCEA public records are available for inspection by contacting Board Clerk Alisa Lembke at (530) 446-2750 or [Alisa.Lembke@ValleyCleanEnergy.org](mailto:Alisa.Lembke@ValleyCleanEnergy.org). Agendas and Board meeting materials can be inspected at VCEA's offices located at 604 Second Street, Davis, California 95616; those interested in inspecting these materials are asked to call (530) 446-2750 to make arrangements. The documents are also available on the Valley Clean Energy website located at: <https://valleycleanenergy.org/about-us/meetings/>

# VALLEY CLEAN ENERGY ALLIANCE

## Staff Report – Item 5

---

**TO:** Valley Clean Energy Alliance Board of Directors  
**FROM:** Alisa Lembke, Board Clerk / Administrative Analyst  
**SUBJECT:** Approval of Minutes from January 9, 2020 Board Meeting  
**DATE:** February 13, 2020

---

### RECOMMENDATION

Receive, review and approve the attached Minutes from the January 9, 2020 Board meeting.



**MINUTES OF THE VALLEY CLEAN ENERGY ALLIANCE  
BOARD OF DIRECTORS MEETING  
THURSDAY, JANUARY 9, 2020**

The Board of Directors of the Valley Clean Energy Alliance duly noticed their special meeting scheduled for Thursday, January 9, 2020 at 5:30 p.m. at the City of Woodland Council Chambers located at 300 1<sup>st</sup> Street, Woodland, California 95695. Chairperson Don Saylor established that there was a quorum present and began the meeting at 5:31 p.m.

Board Members Present: Don Saylor, Dan Carson, Tom Stallard, Lucas Frerichs, Angel Barajas, Wade Cowan, and Jesse Loren

Associate Members Present: Beverly Sandeen

Members Absent: Gary Sandy

Associate Members Absent: Christopher Cabaldon

Approval of Agenda Chairperson Saylor tabled Closed Session Item 4A – Conference with Legal Counsel – Existing Litigation and Item 13 – Approval of Power Purchase Agreement Aquamarine Westside LLC until next meeting. Director Loren made a motion to approve the January 9, 2020 Board Agenda as amended, seconded by Director Barajas. Motion passed with Director Sandy absent.

Public Comment Chairperson Saylor opened the floor for public comment. No public comment.

CLOSED SESSION: Conference with Legal Counsel – Anticipated Litigation The Board adjourned their meeting to go into Closed Session at 5:33 p.m. The Board returned to their regular Agenda at 5:38 p.m. Chairperson Saylor reported that the Board had no reportable action out of closed session.

Approval of Consent Agenda Director Stallard made a motion to approve the Consent Agenda, Items 5 through 11, seconded by Director Cowan. Motion passed unanimously with Director Sandy absent. The following consent items were approved:

5. December 12, 2019 regular Board meeting Minutes;
6. Receipt of 2020 Long Range Calendar;
7. Receipt of Financial Updates – November 30, 2019 (unaudited) financial statements.
8. Receipt of January 3, 2020 Regulatory Update provided by Keyes & Fox;
9. Receipt of January 2, 2020 Customer Enrollment update;
10. Receipt of Community Advisory Committee’s December 5, 2019 Special Meeting Summary; and,



11. Board Member Lucas Frerichs’ participation on the California Community Choice Association (CalCCA) Local Elected’s Coordination Subcommittee.

Consider Draft Guiding Principles related to the potential acquisition of PG&E’s local electricity distribution system

Interim General Manager Mitch Sears introduced this item. He informed those present that CalCCA recently adopted guiding principles. Mr. Sears introduced VCE Staff Victoria Zavattero who briefly reviewed the recommendation.

Staff’s recommendation is to adopt a core set of principles to guide the acquisition, ownership and operation of the local distribution system in Yolo County. The following draft guiding principles were presented.

1. Create and maintain an electric system that is reliable, maximizes safety for all customers and encourages and supports local economic development.
2. Ensure that rates and bills are affordable for all customer classes.
3. Conduct all business in a manner that is ethical, open and transparent to customers and communities.
4. Protect workers by preserving labor agreements and benefits.
5. Develop a governance structure that provides for and encourages customer participation and fosters local decision-making allowing each community to implement energy solutions that are right for them.
6. Demonstrate leadership in climate, clean energy and GHG reduction as well as general environmental stewardship.

Director Loren made a motion to adopt the guiding principles listed above, seconded by Director Carson. Motion passed by the following vote:

- AYES: Saylor, Carson, Stallard, Cowan, Frerichs, Barajas, Loren
- NOES: None
- ABSENT: Sandy
- ABSTAIN: None

Power Purchase Agreement

This item was tabled.

2019 Year-end Review (Informational)

Mr. Sears reviewed VCE’s Integrated Vision Statement – Short Term, Long Term and how these visions were achieved. Mr. Sears informed those present that VCE has either met or exceeded the short-term goals noting that VCE has met the initial 30 days cash reserve and is in progress toward reaching 90 day cash reserve.

Director Stallard inquired with Staff about the joint rate mailer he received. VCE Staff Jim Parks stated that the all CCAs are required to join with their IOU to send



out the rate comparisons to its customers. Director Stallard noted that PG&E’s “green” electricity rate is less expensive than VCE’s UltraGreen rate.

Mr. Sears reviewed the Integrated Vision – Long term. Chairperson Saylor requested that Staff apprise the Board about resource solicitations and/or programs that may be developing within the Board Members’ jurisdictions. He suggested that possibly this could be provided through regular status reports. Mr. Sears reviewed VCE’s notable accomplishments.

VCE Staff George Vaughn reviewed 2019 finance and internal operations and VCE’s financial accomplishments and challenges.

VCE Staff Jim Parks reviewed customer care, marketing and outreach. He informed those present that the most recent marketing campaign was to build awareness of who VCE is.

Mr. Parks reviewed Contact Center Customer Care information and the status of the SACOG “Electrify Yolo” grant. The Board and Staff discussed the SACOG grant. The Board asked that Staff provide more information and a detailed timeline. It is the desire of the Board to move quickly on this grant and they offered their assistance. Director Frerichs asked where the City of Winters fits into the grant. Mr. Parks informed those present that there are plans to install a DC fast charger in Winters.

Director Barajas expressed concern about the opt out rate and if Staff knew why customers were opting out. Mr. Sears informed those present that the opt out rate is within the expected 10% range; however, Staff would like to see this number decrease. Mr. Parks informed those present that customers are asked why they are opting out. Customers have several options to choose from with some marking “other” and others marking that they do not like default enrollment or stating that our rates are higher than PG&E. The Board and Staff discussed approaches to get back customers who opted out.

Mr. Parks reviewed marketing and outreach activities and the next steps on programs.

Chairperson Saylor opened the floor to public comment. Mr. Gene Livingstone asked how VCE generates revenue. Mr. Sears offered to discuss this with Mr. Livingstone after the conclusion of the Board meeting.

Board Member and Staff Announcements

Mr. Sears informed those present that Staff have been going through the recruitment process for an Assistant General Manager/Director of Power Services. It is the hopes that the person will start in early February 2020.



Mr. Sears informed those present that it is anticipated that the River City Bank revolving line of credit will be on the Board's February 2020 agenda.

Mr. Sears informed those present that the Woodland City Manager announced his retirement.

Director Frerichs informed those present that he got involved with the Elected's CalCCA Local Elected Subcommittee when he attended the CalCCA annual meeting in November 2019. This is a coordinate effort with CCA's throughout the State.

Director Saylor informed those present that he would like the Board to be involved in the strategic planning process.

#### Adjournment

Chairperson Saylor adjourned the meeting at 7:06 p.m. to the next meeting scheduled for Thursday, February 13, 2020 at 5:30 p.m. at the City of Davis Community Chambers 23 Russell Boulevard, Davis, California.

Alisa M. Lembke  
VCEA Board Secretary



**VALLEY CLEAN ENERGY ALLIANCE  
Board of Directors Meeting**

**Staff Report - Item 6**

---

**TO:** VCEA Board  
**FROM:** Alisa Lembke, Board Clerk/Administrative Analyst  
**SUBJECT:** Community Advisory Committee 2020 Long-Range Calendar  
**DATE:** February 13, 2020

---

**Recommendation**

Please find attached the Board and Community Advisory Committee long-range calendar for 2020.

Please note that two (2) meetings have been scheduled in the City of Winters:

1. May 14, 2020
2. October 8, 2020

The meetings are scheduled to be held at City of Winters - Police/Fire/Public Safety Facility.

## VALLEY CLEAN ENERGY

### 2020 Meeting Dates and *Proposed* Topics – Board and Community Advisory Committee

MEETING DATE		TOPICS	ACTION
January 9, 2020	<b>Board</b> WOODLAND	•	•
January 23, 2020	<b>Advisory Committee</b> WOODLAND	•	•
February 13, 2020	<b>Board</b> DAVIS	• Power Purchase Agreement	• Action
February 27, 2020	<b>Advisory Committee</b> DAVIS	<ul style="list-style-type: none"> <li>• Task Groups – Present Tasks/Projects</li> <li>• Update on Regulatory Assistance Project</li> </ul>	<ul style="list-style-type: none"> <li>• Informational</li> <li>• Informational</li> </ul>
March 12, 2020	<b>Board</b> WOODLAND	<ul style="list-style-type: none"> <li>• Preliminary FY20/21 Operating Budget (Regular)</li> <li>• River City Bank Revolving Line of Credit</li> <li>• Appoint City of Winters seats to CAC</li> <li>• Power Purchase Agreement</li> </ul>	<ul style="list-style-type: none"> <li>• Review</li> <li>• Action</li> <li>• Action</li> <li>• Action</li> </ul>
March 26, 2020	<b>Advisory Committee</b> WOODLAND	<ul style="list-style-type: none"> <li>• Long Term Load Forecast – Biannual 2020 Integrated Energy Planning Report</li> <li>• Review Draft Integrated Resource Plan (IRP) / Public Workshop, CAC to provide recommendation</li> </ul>	<ul style="list-style-type: none"> <li>• Information</li> <li>• Informational/Action</li> </ul>
April 9, 2020	<b>Board</b> DAVIS	<ul style="list-style-type: none"> <li>• Review Draft Integrated Resource Plan and CAC Recommendation</li> <li>• Long Term Load Forecast – Biannual 2020 Integrated Energy Planning Report</li> <li>• Adoption of Integrated Resource Plan (due May 1, 2020)</li> </ul>	<ul style="list-style-type: none"> <li>• Informational / Action</li> <li>• Information</li> <li>• Action</li> </ul>
April 23, 2020	<b>Advisory Committee</b> DAVIS	•	

May 14, 2020	<b>Board</b> WINTERS	•	•
May 28, 2020	<b>Advisory Committee</b> WOODLAND	• Information related to 2021 Integrated Resource Plan Update	• Information
June 11, 2020	<b>Board</b> DAVIS	<ul style="list-style-type: none"> <li>• Final Approval of FY20/21 Operating Budget</li> <li>• Extension of Waiver of Opt-Out Fees for one more year (??)</li> <li>• Re/Appointment of Members to Community Advisory Committee</li> </ul>	<ul style="list-style-type: none"> <li>• Approval</li> <li>• Action</li> <li>• Action</li> </ul>
June 25, 2020	<b>Advisory Committee</b> DAVIS	<ul style="list-style-type: none"> <li>• Information related to 2021 Integrated Resource Plan Update</li> <li>•</li> </ul>	<ul style="list-style-type: none"> <li>• Discussion</li> <li>•</li> </ul>
July 9, 2020	<b>Board</b> WOODLAND	•	•
July 23, 2020	<b>Advisory Committee</b> WOODLAND	• Information related to 2021 Integrated Resource Plan Update	• Discussion
August 13, 2020	<b>Board</b> DAVIS		
August 27, 2020	<b>Advisory Committee</b> DAVIS	• Revised Procurement Guide – Review	• Discussion
September 10, 2020	<b>Board</b> WOODLAND	<ul style="list-style-type: none"> <li>• Residential Time of Use Rate Classes Report</li> <li>• Discussion on River City Bank Revolving Line of Credit</li> </ul>	<ul style="list-style-type: none"> <li>• Information/Discussion</li> <li>• Discussion</li> </ul>
September 24, 2020	<b>Advisory Committee</b> WOODLAND	<ul style="list-style-type: none"> <li>• Committee Evaluation of Calendar Year End (Draft Report)</li> <li>• Revised Procurement Guide – Review Draft Recommendation</li> </ul>	<ul style="list-style-type: none"> <li>• Discussion</li> <li>• Discussion</li> </ul>
October 8, 2020	<b>Board</b> WINTERS	<ul style="list-style-type: none"> <li>• Approval of FY19/20 Audited Financial Statements (James Marta &amp; Co.)</li> <li>• River City Bank Revolving Line of Credit</li> </ul>	<ul style="list-style-type: none"> <li>• Action</li> <li>• Discussion/Action</li> </ul>
October 22, 2020	<b>Advisory Committee</b> DAVIS	<ul style="list-style-type: none"> <li>• Committee Evaluation of Calendar Year End (Draft Report)</li> <li>• Revised Procurement Guide- Review Draft Recommendation</li> </ul>	<ul style="list-style-type: none"> <li>• Discussion</li> <li>• Discussion</li> </ul>

November 12, 2020	<b>Board</b> WOODLAND	•	•
<del>November 26, 2020</del> Thanksgiving Holiday – Rescheduled to 3 <sup>rd</sup> Thursday, November 19, 2020	<b>Advisory Committee</b> WOODLAND	<ul style="list-style-type: none"> <li>• Committee Evaluation of Calendar Year End (Draft Report)</li> <li>• Revised Procurement Guide – Finalize Recommendation to Board</li> </ul>	<ul style="list-style-type: none"> <li>• Discussion</li> <li>• Action: Recommendation to Board</li> </ul>
December 10, 2020	<b>Board</b> DAVIS	<ul style="list-style-type: none"> <li>• Election of Officers for 2020</li> </ul>	<ul style="list-style-type: none"> <li>• Nominations</li> </ul>
<del>December 24, 2020</del> Rescheduled to 3 <sup>rd</sup> Thursday, December 17, 2020	<b>Advisory Committee</b> DAVIS	<ul style="list-style-type: none"> <li>• Election of Officers for 2020</li> <li>• Finalization of Committee Calendar Year End Report</li> </ul>	<ul style="list-style-type: none"> <li>• Nominations</li> <li>• Approve Report</li> </ul>
January 14, 2021	<b>Board</b> WOODLAND	<ul style="list-style-type: none"> <li>• Receive CAC Calendar Year End Report</li> <li>• Approve Revised Procurement Guide</li> </ul>	<ul style="list-style-type: none"> <li>• Receive Report</li> <li>• Action</li> </ul>
January 28, 2021	<b>Advisory Committee</b> WOODLAND	<ul style="list-style-type: none"> <li>• Review and Discuss Task Groups</li> </ul>	<ul style="list-style-type: none"> <li>• Discuss/Action</li> </ul>

# VALLEY CLEAN ENERGY ALLIANCE

## Staff Report – Item 7

---

**TO:** Valley Clean Energy Alliance Board of Directors

**FROM:** George Vaughn, Finance and Operations Director, VCEA  
Mitch Sears, Interim General Manager, VCEA

**SUBJECT:** Financial Update – December 31, 2019 (unaudited) financial statements (with comparative year to date information) and Actual vs. Budget year to date ending December 31, 2019

**DATE:** February 13, 2020

---

### **RECOMMENDATION:**

Accept the following Financial Statements (unaudited) for the period of December 1, 2019 to December 31, 2019 (with comparative year to date information) and Actual vs. Budget year to date ending December 31, 2019.

### **BACKGROUND & DISCUSSION:**

The attached financial statements are prepared in a form to satisfy the debt covenants with River City Bank pursuant to the Line of Credit and are required to be prepared monthly.

The Financial Statements include the following reports:

- Statement of Net Position
- Statement of Revenues, Expenditures and Changes in Net Position
- Statement of Cash Flows

In addition, staff is reporting the Actual vs. Budget variances year to date ending December 31, 2019.

### Financial Statements for the period December 1, 2019 – December 31, 2019

In the Statement of Net Position, VCEA as of December 31, 2019 has a total of \$13,168,080 in its checking, money market and lockbox accounts, \$1,100,000 restricted assets for the Debt Service Reserve account and \$902,231 restricted assets for the Power Purchases Reserve account. VCEA has incurred obligations from Member agencies and SMUD and owes as of December 31, 2019 \$273,364 and \$578,055 respectively for a grand total of \$851,419. VCEA began paying SMUD for the monthly operating expenditures (starting with December 2018 expenditures) and repayment of the deferred amount of \$1,522,433 over a 24-month period. VCEA began paying the Member agencies for the quarterly

reimbursable expenditures starting in June 2019 and repayment of the deferred amount of \$556,188 over a 12-month period.

The term loan with River City Bank includes a current portion of \$395,322 and a long-term portion of \$1,548,345 as of December 31, 2019, for a total of \$1,943,667. At December 31, 2019, VCE's net position is \$13,770,181.

In the Statement of Revenues, Expenditures and Changes in Net Position, VCEA recorded \$2,629,570 of revenue (net of allowance for doubtful accounts) of which \$3,608,877 was billed in December and (\$858,415) represent estimated unbilled revenue. The cost of the electricity for the December revenue totaled \$2,611,330. For December, VCEA's gross margin is approximately 0.69% and operating income totaled negative (\$318,984). The year-to-date change in net position was \$6,441,348.

In the Statement of Cash Flows, VCEA cash flows from operations was negative (\$1,417,172), due to December cash receipts of revenues exceeding the monthly operating expenses and the SMUD November power invoice being paid after November 30, which made December cash flow less favorable.

#### Actual vs. Budget Variances for the year to date ending December 31, 2019

Below are the financial statement line items with variances >\$50,000 and 5%:

Salaries & Wages/Benefits - (\$129,837) and (43%) – variance is due to having more budgeted filled positions at VCE than we actually have on staff.

SMUD Operating Services - (\$165,026) and (88%) – variance is mainly due to SMUD not having billed for the IRP update and NEM roll-in analysis included in the budget.

PG&E Acquisition Consulting - (\$123,255) and (100%) - variance is due to PG&E asset acquisition expenses not having been applicable at the time the budget was constructed.

Marketing Collateral - (\$99,524) and (90%) - variance is due to major marketing campaigns in the first six months of the year being higher than originally anticipated in the budget

Contingency - (\$117,929) and (100%) - variance is due to VCE not having required usage of contingency funds to date; this is offset by \$123,255 of PG&E acquisition-related expenses.

#### **Attachments:**

- 1) Financial Statements (Unaudited) December 1, 2019 to December 31, 2019 (with comparative year to date information.)
- 2) Actual vs. Budget for year to date ending December 31, 2019



# **VALLEY CLEAN ENERGY**

**VALLEY CLEAN ENERGY ALLIANCE**

**FINANCIAL STATEMENTS**

**(UNAUDITED)**

**FOR THE PERIOD OF DECEMBER 1 TO DECEMBER 31, 2019**

**PREPARED ON FEBRUARY 4, 2020**

**VALLEY CLEAN ENERGY ALLIANCE**  
**STATEMENT OF NET POSITION**  
**DECEMBER 31, 2019**  
**(UNAUDITED)**

**ASSETS**

Cash and cash equivalents	\$	13,168,080
Accounts receivable, net of allowance		3,624,492
Accrued revenue		1,959,825
Prepaid expenses		2,500
Other current assets and deposits		2,540
Total current assets		18,757,437
Restricted assets:		
Debt service reserve fund		1,100,000
Power purchase reserve fund		902,231
Total restricted assets		2,002,231
Noncurrent assets:		
Other noncurrent assets and deposits		100,000
Total noncurrent assets		100,000
<b>TOTAL ASSETS</b>	<b>\$</b>	<b>20,859,668</b>

**LIABILITIES**

Current liabilities:		
Accounts payable	\$	658,247
Accrued payroll		3,496
Interest payable		8,253
Due to member agencies		273,364
Accrued cost of electricity		2,781,610
Other accrued liabilities		851,839
Security deposits - energy supplies		515,640
User taxes and energy surcharges		53,371
Current Portion of LT Debt		395,322
Total current liabilities		5,541,142
Noncurrent liabilities		
Term Loan- RCB		1,548,345
Total noncurrent liabilities		1,548,345
<b>TOTAL LIABILITIES</b>	<b>\$</b>	<b>7,089,487</b>

**NET POSITION**

Restricted		
Local Programs Reserve	\$	137,702
Restricted	\$	2,002,231
Unrestricted		11,630,248
<b>TOTAL NET POSITION</b>	<b>\$</b>	<b>13,770,181</b>



**VALLEY CLEAN ENERGY ALLIANCE**  
**STATEMENT OF REVENUES, EXPENDITURES AND**  
**CHANGES IN NET POSITION**  
**FOR THE PERIOD OF DECEMBER 1, 2019 TO DECEMBER 31, 2019**  
**(WITH COMPARATIVE YEAR TO DATE INFORMATION)**  
**(UNAUDITED)**

	<u>FOR THE</u> <u>PERIOD ENDING</u> <u>DECEMBER 31, 2019</u>	<u>YEAR TO</u> <u>DATE</u>
<b>OPERATING REVENUE</b>		
Electricity sales, net	\$ 2,629,570	\$ 31,095,633
<b>TOTAL OPERATING REVENUES</b>	<u>2,629,570</u>	<u>31,095,633</u>
<b>OPERATING EXPENSES</b>		
Cost of electricity	2,611,330	22,369,285
Contract services	200,587	1,544,833
Staff compensation	94,599	512,748
General, administration, and other	42,038	207,924
<b>TOTAL OPERATING EXPENSES</b>	<u>2,948,554</u>	<u>24,634,790</u>
<b>TOTAL OPERATING INCOME (LOSS)</b>	(318,984)	6,460,843
<b>NONOPERATING REVENUES (EXPENSES)</b>		
Interest income	9,210	41,937
Interest and related expenses	(7,045)	(61,432)
<b>TOTAL NONOPERATING REVENUES (EXPENSES)</b>	<u>2,165</u>	<u>(19,495)</u>
<b>CHANGE IN NET POSITION</b>	(316,819)	6,441,348
Net position at beginning of period	14,087,000	7,328,833
Net position at end of period	<u>\$ 13,770,181</u>	<u>\$ 13,770,181</u>

**VALLEY CLEAN ENERGY ALLIANCE**  
**STATEMENTS OF CASH FLOWS**  
**FOR THE PERIOD OF DECEMBER 1 TO DECEMBER 31, 2019**  
**(WITH YEAR TO DATE INFORMATION)**  
**(UNAUDITED)**

	<u>FOR THE PERIOD ENDING DECEMBER 31, 2019</u>	<u>YEAR TO DATE</u>
<b>CASH FLOWS FROM OPERATING ACTIVITIES</b>		
Receipts from electricity sales	\$ 4,284,058	\$ 34,798,225
Receipts for security deposits with energy suppliers	-	515,640
Payments to purchase electricity	(5,305,555)	(24,591,163)
Payments for contract services, general, and administration	(300,978)	(2,052,894)
Payments for staff compensation	(94,697)	(513,041)
<b>Net cash provided (used) by operating activities</b>	<u>(1,417,172)</u>	<u>8,156,767</u>
<b>CASH FLOWS FROM NON-CAPITAL FINANCING ACTIVITIES</b>		
Loans from member agencies		(1,500,000)
Interest and related expenses	(10,649)	(165,491)
<b>Net cash provided (used) by non-capital financing activities</b>	<u>(43,593)</u>	<u>(1,698,434)</u>
<b>CASH FLOWS FROM INVESTING ACTIVITIES</b>		
Interest income	9,210	41,937
<b>Net cash provided (used) by investing activities</b>	<u>9,210</u>	<u>41,937</u>
<b>NET CHANGE IN CASH AND CASH EQUIVALENTS</b>	(1,451,555)	6,500,270
Cash and cash equivalents at beginning of period	16,621,866	8,670,042
<b>Cash and cash equivalents at end of period</b>	<u>\$ 15,170,311</u>	<u>\$ 15,170,312</u>
Cash and cash equivalents included in:		
Cash and cash equivalents	\$ 13,168,080	\$ 13,168,080
Restricted assets	2,002,231	2,002,231
<b>Cash and cash equivalents at end of period</b>	<u>\$ 15,170,311</u>	<u>\$ 15,170,311</u>

**VALLEY CLEAN ENERGY ALLIANCE**  
**STATEMENTS OF CASH FLOWS**  
**FOR THE PERIOD OF DECEMBER 1 TO DECEMBER 31, 2019**  
**(WITH YEAR TO DATE INFORMATION)**  
**(UNAUDITED)**

	<u>FOR THE PERIOD ENDING DECEMBER 31, 2019</u>	<u>YEAR TO DATE</u>
<b>RECONCILIATION OF OPERATING INCOME TO NET CASH PROVIDED (USED) BY OPERATING ACTIVITIES</b>		
Operating Income (Loss)	\$ (318,984)	\$ 6,460,843
Adjustments to reconcile operating income to net cash provided (used) by operating activities:		
(Increase) decrease in net accounts receivable	781,027.00	1,370,781.00
(Increase) decrease in accrued revenue	859,732	2,335,888.00
(Increase) decrease in prepaid expenses	9,497	(2,500.00)
(Increase) decrease in inventory - renewable energy credits	76,820	207,168.00
Increase (decrease) in accounts payable	56,790	72,127.00
Increase (decrease) in accrued payroll	(98)	(293.00)
Increase (decrease) in due to member agencies	(19,492)	(136,945.00)
Increase (decrease) in accrued cost of electricity	(2,771,045)	(2,429,046.00)
Increase (decrease) in other accrued liabilities	(105,148)	(232,819.00)
Increase (decrease) security deposits with energy suppliers	-	515,640.00
Increase (decrease) in user taxes and energy surcharges	13,729	(4,077.00)
<b>Net cash provided (used) by operating activities</b>	<b>\$ (1,417,172)</b>	<b>\$ 8,156,767</b>

**VALLEY CLEAN ENERGY**  
**ACTUAL VS. BUDGET FYE 6-30-2020**  
**FOR THE YEAR TO DATE ENDING 12-31-19**

Description	12/31/2019	12/31/2019	YTD Variance	% over/-under
	YTD FY2020 Actuals	YTD FY2020 Budget		
Electric Revenue	\$ 31,095,631	\$ 32,234,286	\$ (1,138,655)	-4%
Interest Revenues	41,938	54,829	(12,891)	-24%
Purchased Power	22,369,285	22,501,286	(132,002)	-1%
Labor & Benefits	512,749	589,459	(76,710)	-13%
Salaries & Wages/Benefits	174,571	304,408	(129,837)	-43%
Contract Labor	324,316	278,751	45,565	16%
Human Resources & Payroll	13,863	6,300	7,563	120%
Office Supplies & Other Expenses	65,041	63,945	1,096	2%
Technology Costs	5,092	4,632	460	10%
Office Supplies	1,251	613	638	104%
Travel	4,218	2,400	1,818	76%
CalCCA Dues	54,480	54,500	(20)	0%
Memberships	-	1,800	(1,800)	-100%
Contractual Services	1,544,806	1,539,467	5,339	0%
Don Dame	11,037	9,000	2,037	23%
SMUD - Credit Support	277,273	324,612	(47,339)	-15%
SMUD - Wholesale Energy Services	282,072	282,072	-	0%
SMUD - Call Center	330,099	333,482	(3,384)	-1%
SMUD - Operating Services	21,974	187,000	(165,026)	-88%
Legal	67,101	84,000	(16,899)	-20%
Regulatory Counsel	86,144	92,640	(6,496)	-7%
Joint Regulatory	33,612	15,000	18,612	124%
Legislative	30,000	30,000	-	0%
Accounting Services	8,554	12,000	(3,446)	-29%
Audit Fees	63,000	58,500	4,500	8%
PG&E Acquisition Consulting	123,255	-	123,255	100%
Marketing Collateral	210,685	111,161	99,524	90%
Rents & Leases	8,649	8,652	(3)	0%
Hunt Boyer Mansion	8,649	8,652	(3)	0%
Other A&G	118,632	153,998	(35,366)	-23%
PG&E Data Fees	115,905	116,719	(814)	-1%
Community Engagement Activities & Sponsorships	126	3,000	(2,874)	-96%
Insurance	2,601	3,679	(1,078)	-29%
New Member Expenses	-	30,000	(30,000)	-100%
Banking Fees	-	600	(600)	-100%
Miscellaneous Operating Expenses	15,629	3,066	12,563	410%
Contingency	-	117,929	(117,929)	-100%
<b>TOTAL OPERATING EXPENSES</b>	<b>\$ 24,634,790</b>	<b>\$ 24,977,803</b>	<b>\$ (343,013)</b>	<b>-1%</b>
Interest Expense - Munis	14,965	27,716	(12,751)	-46%
Interest on RCB loan	38,463	43,582	(5,119)	-12%
Interest Expense - SMUD	8,004	8,637	(633)	-7%
Miscellaneous Non-Operating	-	-	-	0%
<b>NET INCOME</b>	<b>\$ 6,441,348</b>	<b>\$ 7,231,378</b>	<b>\$ (790,030)</b>	<b>-11%</b>

# VALLEY CLEAN ENERGY ALLIANCE

## Staff Report – Item 8

---

To: Valley Clean Energy Alliance Board of Directors

From: Mitch Sears, Interim General Manager

Subject: Regulatory Monitoring Report – Keyes & Fox

Date: February 13, 2020

---

Please find attached Keyes & Fox's January 2020 Regulatory Memorandum dated February 6, 2020, an informational summary of the key California regulatory and compliance-related updates from the California Public Utilities Commission (CPUC).

**Attachment:** Keyes & Fox Regulatory Memorandum dated February 6, 2020

# Valley Clean Energy Alliance

## Regulatory Monitoring Report

---

To: Valley Clean Energy Alliance (“VCE”) Board of Directors

From: Sheridan Pauker, Partner, Keyes & Fox, LLP  
Tim Lindl, Partner, Keyes & Fox LLP  
Ben Inskeep, Sr. Analyst, EQ Research, LLC

Subject: Regulatory Update

Date: February 6, 2020

---

### Summary

Keyes & Fox LLP and EQ Research, LLC, are pleased to provide VCE’s Board of Directors with this monthly informational memo describing key California regulatory and compliance-related updates from the California Public Utilities Commission (CPUC). A Glossary of Acronyms used is provided at the end of this memo.

In summary, this month’s report includes regulatory updates on the following priority issues:

- **PG&E’s 2020 ERRA Forecast:** On January 24, 2020, the ALJ issued a Proposed Decision (PD) that would increase the system average PCIA for the 2017 vintage to \$0.0317/kWh (capped) and \$0.0423/kWh (uncapped, including a refund that will be granted via the ERRA Compliance docket – next bullet).
- **PG&E’s 2018 ERRA Compliance:** The ALJ issued a PD that would approve the settlement agreement between PG&E, Public Advocates Office, and the Joint CCAs (EBCE, PCE, and SVCE). Public Advocates Office filed comments on the PD. The PD establishes the amount of the refund for a prior misallocation related to the Cost Allocation Mechanism.
- **2018 Rate Design Window:** The ALJs issued a PD addressing Phase 3 issues (primarily residential fixed charges and minimum bills) that would largely retain the overarching design of residential rates as they are now.
- **RPS Rulemaking:** VCE and other retail sellers filed updated 2019 RPS Procurement Plans, as directed by the CPUC in D.19-12-042. EnerCal filed a Petition for Modification of D.19-12-042, requesting to be removed from the list of entities the CPUC found to be deficient in its 2019 RPS Procurement Plan filing.
- **Investigation of PG&E Bankruptcy Plan:** The ALJ amended the schedule in response to a motion by PG&E. The unsecured noteholders filed a Motion to withdraw from the proceeding following an agreement it reached with PG&E to support its reorganization plan. The ALJ issued a Ruling granting in part the Motion. PG&E filed Notice of its amended reorganization plan with supporting testimony. A wildfire victim requested evidentiary and public participation hearings.
- **Investigation into PG&E Violations Related to Wildfires:** PG&E filed a response to an ALJ Ruling requesting more information on the implications of the Settlement Agreement. The ALJ issued a Ruling canceling the dates for the evidentiary hearing and briefing in light of the

Settlement Agreement. The AHC filed a Motion to withdraw from the proceeding following an agreement it reached with PG&E to support its reorganization plan. Parties filed comments and reply comments on the Settlement Agreement.

- **IRP Rulemaking:** Parties filed reply comments on the ALJ's Ruling on the proposed Reference System Portfolio. The ALJ issued a Ruling allowing LSEs to file updated load forecasts out to 2030. GenOn Holdings and the City of Oxnard filed a Petition for Modification of D.19-11-016. The ALJ extended the deadlines established in a January 24, 2020, Ruling, as well as notified parties that the IRP filing deadline would be extended to July 1, 2020. A workshop on the modified cost allocation for backstop procurement was also held.
- **RA Rulemaking (2021-2022):** Commissioner Randolph issued a Scoping Memo and Ruling.
- **RA Rulemaking (2019-2020):** The Assigned Commissioner issued a Ruling providing Energy Division's State of the Market Resource Adequacy Report, revised to include October-December 2019 data. The CPUC issued D.20-01-004 addressing a September 2019 Motion from a group of solar and storage parties to establish the RA qualifying capacity of hybrid resources (i.e., storage paired renewables) for both in front of the meter and behind the meter configurations.
- **PG&E's Phase 1 GRC:** The ALJs issued a Ruling granting a PG&E motion for oral argument. The AHC filed a Motion to withdraw from the proceeding following an agreement it reached with PG&E to support its reorganization plan. PG&E filed a Motion requesting official notice of information in its 10-K Annual Reports showing its total number of electric and gas customers for 2013-2018. Parties filed comments and reply comments on the proposed Settlement Agreement. Parties also filed reply briefs on disputed issues outside of the Settlement Agreement.
- **PG&E's Phase 2 GRC:** Parties including a group of northern California CCAs protested PG&E's Phase 2 GRC application and PG&E filed its response. A prehearing conference was held.
- **PCIA Rulemaking:** Comments and reply comments on Working Group 2's (Prepayment) Final Report were filed by parties. The ALJ issued rulings modifying the procedural schedule to push back the date of Working Group 3's report (Portfolio Optimization and Cost Reduction and Allocation and Auction) and opportunities for comments and replies. The CPUC issued D.20-01-030, which modifies D.18-10-019 (October 2018) and denies requests for its rehearing.
- **Direct Access Rulemaking:** A workshop was held on an Energy Division study that will inform the CPUC's recommendations to the Legislature on further expanding Direct Access. Workshop parties submitted informal comments and reply comments.
- **Wildfire Cost Recovery Methodology Rulemaking:** No updates this month. (An August PG&E Application for Rehearing remains pending regarding D.19-06-027, establishing criteria and a methodology for wildfire cost recovery, which has been referred to as a "Stress Test" for determining how much of wildfire liability costs that utilities can afford to pay.)
- **Investigation into PG&E's Organization, Culture and Governance:** No significant updates this month. The AHC filed a Motion to withdraw from the proceeding following an agreement it reached with PG&E to support its reorganization plan.
- **Wildfire Fund Non-Bypassable Charge (AB 1054):** No significant updates this month. The AHC filed a Motion to withdraw from the proceeding following an agreement it reached with PG&E to support its reorganization plan. (In November, a citizen intervenor filed an Application for Rehearing of D.19-10-056, which approved the imposition of a non-bypassable charge to fund the Wildfire Fund.)
- **Other Regulatory Developments:**
  - **CPUC Approves Changes to SGIP Funding:** On January 27, the CPUC issued [D.20-01-021](#) establishing funding and program design for the 2020-2024 SGIP Program.

- **CPUC Modifies GRC Filing Schedule:** The CPUC issued [D.20-01-002](#), changing the timing of large IOU general rate case (GRC) filings from a three-year to a four-year cycle (Docket No. [R.13-11-006](#)) beginning after the 2023 GRC.
- **CPUC Approves Changes to SGIP Funding:** On January 27, the CPUC issued [D.20-01-021](#) establishing funding and program design for the 2020-2024 SGIP Program.

## PG&E’s 2020 ERRA Forecast

On January 24, 2020, the ALJ issued a Proposed Decision (PD).

- **Background:** ERRA forecast proceedings establish the amount of the PCIA and other non-bypassable charges for the following year, as well as fuel and purchased power costs associated with serving bundled customers that utilities may recover in rates.

PG&E is proposing to increase the uncapped 2020 PCIA rates for residential customers from \$0.02709/kWh to \$0.04548/kWh for 2017 vintage customers and from \$0.02979/kWh to \$0.04567/kWh for 2018 vintage customers. A cap limiting the increase to \$0.005/kWh would apply to each of these rates, subject to a potential trigger mechanism that would increase the rates beyond the cap. The PCIA rate for 2020 vintage residential customers, which is not capped because there is no cap for bundled customers (which make up the 2020 vintage), would be \$0.04452/kWh. Of note, PG&E expects CCA and DA providers to serve more than 54% of PG&E’s system retail sales in 2020.

**Details:** The PD generally sides with PG&E on the remaining contested issues (PG&E had already agreed to changes on nearly \$700 million worth of issues prior to the PD). The PD would approve the following revenue requirements as proposed and subsequently revised by PG&E:

- The 2020 ERRA revenue requirement of \$3.014 billion.
  - The PCIA revenue requirement of \$3.149 billion.
  - The Competition Transition Charge (CTC) revenue requirement of \$112 million.
  - The Cost Allocation Mechanism (CAM) revenue requirement of \$205 million.
  - The Tree Mortality Non-Bypassable Charge revenue requirement of \$102 million.
  - The utility-owned generation revenue requirement of \$2.260 billion.
- **Analysis:** This proceeding will establish the amount of the PCIA for VCE’s 2020 rates and the level of PG&E’s generation rates for bundled customers. The PCIA revenue requirement detailed above is now shared between bundled and unbundled customers. PG&E’s requested PCIA revenue requirement for unbundled customers is nearly \$1.7 billion, nearly double the final revenue requirement for unbundled customers from last year.
  - **Next Steps:** Opening and reply comments, respectively, are due February 13 and February 18, 2020. The PD may be heard, at the earliest, at the CPUC’s February 27, 2020, Business Meeting.
  - **Additional Information:** [Proposed Decision](#) (January 24, 2020); [E-Mail Ruling](#) extending comments deadline on November Update. [Scoping Memo and Ruling](#) (August 22, 2019); [Application](#) (June 3, 2019); [Testimony](#) available on PG&E’s regulatory webpage (June 3, 2019); Docket No. [A.19-06-001](#).

## PG&E’s 2018 ERRA Compliance

On December 31, 2020, the ALJ issued a PD that would approve the settlement agreement between PG&E, Public Advocates Office, and the Joint CCAs (EBCE, PCE, and SVCE). On January 21, Public Advocates Office filed comments on the PD. No party filed reply comments.



- **Background:** ERRA compliance review proceedings review the utility's compliance in the preceding year regarding energy resource contract administration, least-cost dispatch, fuel procurement, and the ERRA balancing account. In its application, PG&E requested that the CPUC find that it 2018 PG&E complied with its CPUC-approved Bundled Procurement Plan (BPP) in the areas of fuel procurement, administration of power purchase contracts, greenhouse gas compliance instrument procurement, and least-cost dispatch of electric generation resources, as well as that it managed its utility-owned generation (UOG) facilities reasonably. PG&E also requested recovery of \$4.7 million for Diablo Canyon seismic study costs.
- **Details:** The PD would approve the Settlement Agreement resolving all disputed issues raised by parties to this proceeding. In the Settlement Agreement, the Joint CCAs agreed to withdraw their recommendation that PG&E be required to provide more details on the timing and methodology used to distribute over-collected funds via PCIA, determining that the July 29, 2019 Supplemental Testimony submitted in PG&E's 2020 ERRA Forecast Application (A.19-06-001) contains sufficient information to determine that both bundled and unbundled customers will see simultaneous rate adjustments addressing the prior misallocation of Cost Allocation Mechanism-related costs through the PCIA component of their respective rates. Those adjustments to the PCIA will occur through the Portfolio Allocation Balancing Account to avoid a situation where now-departed customers pay twice for the same energy and capacity. PG&E agreed to participate in a workshop with other California IOUs in order to develop and standardize renewable and storage resource reporting requirements and to certain modest cost disallowances.
- **Analysis:** This proceeding will address whether PG&E correctly calculated and accounted for the actual costs it incurred in 2018 and whether it managed its portfolio of contracts and UOG in a reasonable manner.
- **Next Steps:** This PD is unopposed on the consent agenda for the CPUC's February 6, 2020 Business Meeting.
- **Additional Information:** [Proposed Decision](#) approving Settlement Agreement (December 31, 2019); [Scoping Memo and Ruling](#) (June 3, 2019); [Notice of Prehearing Conference](#) (April 17, 2019); [Response](#) of EBCE and PCE (April 5, 2019); [Resolution](#) categorizing proceeding as ratesetting (March 14, 2019); [PG&E Application](#) (February 28, 2019); Docket No. [A.19-02-018](#).

## 2018 Rate Design Window

On February 5, 2020, the ALJs issued a Proposed Decision addressing Phase 3 issues (primarily residential fixed charges and minimum bills) that would largely retain the overarching design of residential rates as they are now.

- **Background:** The IOUs' RDW applications have been consolidated into one proceeding. This proceeding is divided into three phases, with the second phase further bifurcated. A May 2018 [Phase 1](#) Decision granted PG&E approval to begin transitioning eligible residential customers to TOU rates beginning in October 2020. A December 2018 [Phase 2A](#) Decision addressed PG&E's restructuring of the CARE discounts into a single line item percentage discount to the customer's total bill. The July 2019 [Phase 2B](#) Decision made determinations regarding PG&E's rate design under its default TOU roll out beginning in October 2020 and established a process for a CCA wishing to have its customers defaulted to TOU generation rates. The proceeding is now focused on [Phase 3](#), which considers the IOUs' proposals for fixed charges and/or minimum bills.
- **Details:** The PD would find that the utilities failed to demonstrate that their fixed charge proposals would be met with customer acceptance and understanding of what would be a novel rate design for California. It would reject PG&E's proposal to establish a \$6.37/month fixed charge. The PD would allow PG&E to increase the standard minimum bill amount, currently \$10/month, for 2020 to reflect the CPI inflation percentages for 2018 and 2019, with an annual CPI adjustment

beginning in 2021. The CARE rate will remain at the current \$5/month rate as adjusted for inflation.

The PD would direct that the minimum bill amounts be calculated based on distribution charges only beginning October 1, 2020. This is a shift from present design under which the minimum bill is assessed based on all non-generation volumetric rates, which also include transmission and other non-bypassable charges. It also would determine that if a customer does pay a fixed charge under an optional rate that they choose to enroll in, the customer may not also be charged a minimum bill.

- **Analysis:** This proceeding will impact the timing, details, and implementation of residential TOU rates for bundled PG&E customers as well as VCE customers via rate design changes to the distribution component of customer bills. It could affect the level of VCE's rates compared to PG&E's, and to the extent VCE mirrors PG&E's residential rate design, lead to changes in the way VCE structures its residential rates. CCAs are not obligated to default their customers to TOU generation rates, but regardless of whether a CCA offers TOU generation rates, CCA customers will be subject to default TOU distribution rates. However, the pending Track 3 PD, if adopted, would not result in major residential rate design changes for PG&E customers, as it rejects PG&E's proposed fixed charge and only slightly modifies PG&E's existing minimum bill.
- **Next Steps:** Comments on the PD are due February 25, 2020, replies are due March 2, 2020, and the PD may be adopted, at the earliest, at the CPUC's March 12, 2020, meeting.
- **Additional Information:** [Proposed Decision](#) on Track 3 issues (February 5, 2020); [D.19-07-004](#) in Phase IIB (July 19, 2019); PG&E Phase III [Revised Testimony](#) on fixed charges (April 12, 2019, and March 29, 2019); [D.18-12-004](#) on Phase IIA Issues (December 21, 2018); [Ruling](#) clarifying scope (July 31, 2018); [D.18-05-011](#) (Phase I) on the timing of a transition to default TOU rates (May 17, 2018); [Amended Scoping Memo](#) (April 10, 2018); PG&E Rate Design Window Application & Testimony (December 20, 2017); Docket No. [A.17-12-011](#) (consolidated).

## RPS Rulemaking

On January 7, 2020, EnerCal filed a Petition for Modification of D.19-12-042, requesting to be removed from the list of entities the CPUC found to be deficient in its 2019 RPS Procurement Plan filing. On January 29, 2020, VCE and other retail sellers filed updated 2019 RPS Procurement Plans, as directed by the CPUC in D.19-12-042.

- **Background:** This proceeding addresses ongoing RPS issues. VCE filed its 2019 RPS Procurement Plan on June 21, 2019, and its 2018 RPS Compliance Report on August 1, 2019. D.19-12-042, issued December 2019, required VCE to file an updated 2019 RPS Procurement Plan to address two deficiencies identified: (1) Least-Cost, Best-Fit (LCBF) information and (2) demonstration of compliance with the long-term contracting requirement.
- **Details:** EnerCal requested modification to be removed from the list of entities found to have filed a deficient 2019 RPS Procurement Plan, saying it has never served load in California, so it does not have RPS requirements, and its inclusion in the list of deficient entities required to refile within 30 days was in error. VCE has asked the CPUC's Energy Division to look into whether the finding that its 2019 RPS Procurement Plan was deficient was the result of a clerical error.
- **Analysis:** D.19-09-007 on new CCAs' 2018 RPS Procurement Plans, D.19-08-007 on RPS enforcement actions for two ESPs, and D.19-12-042 on 2019 RPS Procurement Plans together reinforce the CPUC's increasing scrutiny of CCAs and their compliance obligations, and the potentially large penalties associated with non-compliance.

Remaining issues to be addressed in this proceeding include a determination on the revised 2019 RPS Procurement Plans, as well as issues that could impact future RPS compliance obligations, such as potentially allowing LSEs like VCE to forgo filing a separate RPS Procurement Plan in 2022 by using its 2022 IRP filing instead.

- **Next Steps:** The CPUC will review revised 2019 RPS Procurement Plans filed by retail sellers in January and make a determination on whether to approve them.

In 2020, the Energy Division is developing a proposal (potentially including workshops or working groups) on integrating the IRP and RPS Procurement Plan filings, but the possibility of combining these filings will not occur prior to 2022, per D.19-12-042.

- **Additional Information:** [EnerCal's Petition for Modification](#) of D.19-12-042 (January 7, 2020); [D.19-12-042](#) on 2019 RPS Procurement Plans (December 30, 2019); [D.19-09-043](#) on ELCC modeling (September 26, 2019); [D.19-09-007](#) on new CCAs' 2018 RPS Procurement Plans (September 18, 2019); [D.19-08-007](#) on RPS enforcement actions (August 7, 2019); [D.19-06-023](#) on implementing SB 100 (May 22, 2019); [Ruling](#) extending procedural schedule (May 7, 2019); [Ruling](#) identifying issues, schedule and 2019 RPS Procurement Plan requirements (April 19, 2019); [D.19-02-007](#) (February 28, 2019); [Scoping Ruling](#) (November 9, 2018); Docket No. [R.18-07-003](#).

## Investigation of PG&E Bankruptcy Plan

On January 16, 2020, PG&E filed a Motion to modify the procedural schedule, which the ALJ granted in part. On January 23, 2020, the Ad Hoc Committee of Senior Unsecured Noteholders of PG&E (AHC) filed a Motion to withdraw from the proceeding following an agreement it reached with PG&E to support its reorganization plan. The ALJ issued a Ruling granting in part the Motion on January 30, 2020. On January 31, 2020, PG&E filed Notice of its amended reorganization plan with supporting testimony. On February 2, 2020, a wildfire victim (Will Abrams) again requested evidentiary and public participation hearings.

- **Background:** On September 9, 2019, PG&E filed a proposed plan of reorganization in the United States Bankruptcy Court. A subsequent Ruling of the Bankruptcy Court terminated PG&E's exclusive right to file a plan of reorganization and permitted the filing of an alternative plan (characterized as a "hostile takeover" by PG&E) proposed by the AHC. Under AB 1054, in order for PG&E to be eligible to participate in the Wildfire Fund, its plan must be "neutral, on average, to ratepayers." The case will address regulatory review and approval of the plan, in particular the questions surrounding whether the plan meets the requirements AB 1054 imposes for PG&E to participate in the newly established Wildfire Fund, which is encumbered by a June 30, 2020 deadline. This proceeding will consider the ratemaking implications of the proposed plan and settlement agreement, whether the plan satisfactorily resolves claims for monetary fines or penalties for PG&E's pre-petition conduct, whether to approve the governance structure of the utility and the appropriate disposition of potential changes to PG&E's corporate structure and authorization to operate, whether to make any other approvals related to the confirmation and implementation of the plan, and any other findings necessary to approve a proposed settlement, including but not limited to whether doing so is in the public interest.

PG&E's reorganization plan would result in a \$13.5 billion Fire Victim Trust and a \$11 billion settlement with insurance claim holders and companies. The Fire Victim Trust will be funded through \$6.75 billion in cash, and \$6.75 billion in stock of reorganized PG&E Corp., representing at least a 20.9% share ownership of the reorganized PG&E Corp. Notably, tort claimants of PG&E have shifted their support from the plan of the Ad Hoc Committee of Senior Unsecured Noteholders of PG&E to the amended plan proposed by PG&E.

- **Details:** On January 22, PG&E announced that it had reached an agreement with AHC regarding its reorganization plan. This agreement was approved by the Bankruptcy Court on February 4, 2020. The Restructuring Support Agreement executed by PG&E and AHC required AHC to file motions for leave to withdraw all filings submitted in any proceeding before the CPUC involving PG&E and cease participation in any proceeding before the CPUC involving the PG&E. Accordingly, AHC filed motions to withdraw from various proceedings, including I.19-09-016. The ALJ subsequently issued a Ruling granting in part AHC's Motion, clarifying that AHC pleadings in this proceeding that have been accepted for filing will remain in the record of this proceeding and

not withdrawn. AHC documents that have been served but not filed are not part of the record, but remain publicly available. AHC witnesses will not be subject to cross-examination.

PG&E's amended reorganization plan now addresses the claims of holders of utility prepetition funded debt, separately classifies Ghost Ship Fire Claims from other Fire Claims (i.e., rather than channeling them through the Fire Victim Trust), clarifies that all accrued and unpaid payments as of the Effective Date that are due under the Debtors' Employee Benefit Plans will be paid on or as soon as practicable after the Effective Date, and incorporates agreements with IBEW Local 1245.

PG&E, saying it has "moved too far from our customers," now proposes as part of its reorganization plan to create local operating regions, as well as expanding its enterprise and risk management program, adding a new Chief Risk Officer and Chief Safety Officer, taking aggressive action to reduce the number of customers affected by PSPS de-energization events. PG&E requests that the CPUC rule in Docket No. I.15-08-019 that PG&E will not be forced to sell the gas business, to eliminate the holding company, or to municipalize and that the Commission will not institute a review of or make modifications to its certificate of public convenience and necessity

- **Analysis:** This proceeding will allow the CPUC to approve a restructuring plan for PG&E, which ultimately must secure approval for the plan by the federal Bankruptcy Court. The express exclusion of municipalization issues from the scope of the proceeding has implications for VCE and its bid to PG&E to purchase the transmission and distribution assets of PG&E as part of PG&E's restructuring. The stock component of the amended reorganization plan could align tort claimants with PG&E in ways that are detrimental to VCE's bid for municipalization and other interests as well. VCE is a party to this proceeding.
- **Next Steps:** Reply testimony is now due February 14, 2020. Evidentiary hearings are scheduled for February 19-28, 2020. Opening and reply briefs, respectively, are due March 13, 2020, and March 20, 2020. A PD on financial issues is targeted for April 2020. The CPUC intends to complete the proceeding sufficiently in advance of the June 30, 2020 deadline in order to allow the bankruptcy court sufficient time to address and approve any changes to the plan that result from CPUC directives.
- **Additional Information:** [PG&E Notice of Amended Plan of Reorganization](#) and [Testimony](#) (January 31, 2019); [Ruling](#) granting in part AHC motion to withdraw (January 30, 2020); [Ruling](#) modifying procedural schedule (January 16, 2020); [Ruling](#) on Section 854 (November 27, 2019); [Scoping Memo and Ruling](#) (November 14, 2019); [PG&E Amended Plan](#) (November 5, 2019); [Order Instituting Investigation](#) (October 4, 2019); Docket No. [I.19-09-016](#).

## Investigation into PG&E Violations Related to Wildfires

On January 10, 2020, PG&E filed a response to an ALJ Ruling requesting more information on the implications of the Settlement Agreement. On January 16, 2020, parties filed comments on the proposed Settlement Agreement. On January 21, 2020, the ALJ issued a Ruling canceling the dates for the evidentiary hearing and briefing in light of the Settlement Agreement. On January 23, 2020, the AHC filed a Motion to withdraw from the proceeding following an agreement it reached with PG&E to support its reorganization plan. On January 31, 2020, parties filed reply comments on the Settlement Agreement.

- **Background:** The CPUC opened this formal investigation to determine whether PG&E violated any laws, rules, or other applicable requirements pertaining to the maintenance and operation of electric facilities involved in igniting fires in its service territory in 2017. SED issued a Fire Report on June 13, 2019 that found deficiencies in PG&E's vegetation management practices and procedures and equipment operations in severe conditions. CAL FIRE also found that PG&E's electrical facilities ignited all but one of the fires addressed in this investigation. This investigation addresses fire incidents from the October 2017 Fire Siege investigated by SED and will determine whether PG&E's practices have been unsafe and in violation of the law. This investigation orders PG&E to take immediate corrective actions to come into compliance with

CPUC requirements. The scope of the proceeding includes violations of law by PG&E with respect to the 2017 and 2018 wildfires, including the 2017 Tubbs Fire and the 2018 Camp Fire, what penalties should be assessed, what remedies or corrective actions should occur, and what if any systemic issues contributed to the ignition of the wildfires.

The terms of the Settlement Agreement specify that PG&E's shareholders are on the hook for \$1.675 billion in financial obligations as a result of numerous wildfires its equipment played a role in sparking in 2017 and 2018. Specifically, PG&E would not be permitted seek rate recovery of wildfire-related expenses and capital expenditures totaling \$1.625 billion. In addition, PG&E would be required to spend \$50 million in shareholder-provided settlement funds on specified System Enhancement Initiatives.

- **Details:** In comments filed January 16, 2020, the City and County of San Francisco requested the settlement be modified to require the PG&E serve its Quarterly Electric Maintenance reports to local governments in its service territory that request them and to post them on its website and to provide locational information in an easier to understand format.
- **Analysis:** This investigation could result in a large penalty against PG&E and require additional corrective actions to mitigate future wildfire risk, potentially impacting the quality of service experienced by VCE customers and costs paid by VCE and other distribution customers. Monetary penalties would ultimately be handled in the Bankruptcy Court. Prepetition liabilities must be resolved in this proceeding so that PG&E can emerge from bankruptcy within the time frame provided in AB 1054 (i.e. June 30, 2020).
- **Next Steps:** TBD.
- **Additional Information:** [Ruling](#) modifying procedural schedule (January 21, 2020); [Joint Motion for Approval of Settlement Agreement](#) (December 17, 2019); [Ruling](#) amending scope (December 5, 2019); [Report on Camp Fire](#) (November 26, 2019; *Note: Large File, 259 MB*); [Ruling](#) granting extension of proceeding schedule (November 25, 2019); [Amended Scoping Memo and Ruling](#) (October 28, 2019); GO 95 [Rule 31.1](#); GO 95 [Rule 35](#); GO 95 [Rule 38](#); [Order Instituting Investigation](#) (June 27, 2019); Docket No. [I.19-06-015](#).

## IRP Rulemaking

Parties filed reply comments on the ALJ's Ruling on the proposed Reference System Portfolio on January 6, 2020. On January 24, 2020, the ALJ issued a Ruling allowing LSEs to file updated load forecasts out to 2030. On January 24, 2020, GenOn Holdings and the City of Oxnard filed a Petition for Modification of D.19-11-016. On January 31, 2020, the ALJ extended the deadlines established in the January 24, 2020, Ruling, as well as notified parties that the IRP filing deadline would be extended to July 1, 2020. On February 3, 2020, a workshop on the modified cost allocation for backstop procurement was held.

- **Background:** In the CPUC's IRP process, the RSP is essentially a proposed statewide IRP portfolio that sets a statewide benchmark for later IRPs filed by individual LSEs. The CPUC ultimately adopts a Preferred System Portfolio (PSP) to be used in statewide planning and future procurement. In May 2019, the CPUC issued D.19-04-040, which rejected an aggregation of each of the LSEs' IRPs (the Hybrid Conforming Portfolio) as the statewide PSP, adopting instead a modified version of the Reference System Plan adopted in D.18-02-018 as its PSP. D.19-04-040 opened a new "procurement track" of the proceeding to determine how LSEs are to procure resources to satisfy the PSP by 2030.

D.19-11-016 recommends meeting the potential RA capacity shortage identified through two tranches. Tranche 1 consists of a *recommendation* that the state Water Resources Control Board (Water Board) extend the retirement dates for several existing generation facilities that use once-through cooling (OTC) systems (~3,750 MW of capacity slated to retire December 31, 2020).

Tranche 2 consists of a mandatory procurement of 3,300 MW of additional capacity from resources incremental to baseline capacity included in the 2022 PSP. The procurement obligation applies to all LSEs, including VCE. At least 50% of resources must be on-line by August

1, 2021, 75% by August 1, 2022, and 100% by August 1, 2023. VCE's incremental system RA procurement requirements for these respective deadlines are 6.3 MW, 9.4 MW, and 12.6 MW. Contracts for new resources must generally be for at least 10 years but energy efficiency resources are allowed under 5 year contracts. Contracts for existing resources must be for at least 3 years.

The November Ruling requested comments on the proposed RSP that would be used for LSE IRP filings due May 1, 2020. Specifically, the Ruling requested comments on the details of the modeling used to produce the RSP (e.g., assumptions, scenarios, sensitivity analyses) as well as the results of the modeling, various concerns that those results could raise and potential actions, and the process for aggregating individual LSE IRPs to form the basis for the ultimate statewide PSP. Of note, Staff added a 5 GW import constraint into the model for all hours when gross electric demand is higher than the 95th percentile. The incremental resource buildout under the default modeling scenario includes 2,837 MW of wind, 11,774 MW of solar, 11,384 MW of battery storage, and 222 MW of load shed demand response.

- **Details:** In D.19-11-016, the CPUC recommended that the compliance deadline for GenOn's Ormond Beach Generating Station under California's Once-Through Cooling Policy be extended for one year. GenOn Holdings and the City of Oxnard have reached an agreement that would resolve previous concerns about extending the life of this facility, and now request modification of the decision to recommend the extension last for three years (through December 31, 2023).

The ALJ's rulings allow for updated load forecast filings for the 2021-2030 time period for non-IOU LSEs wanting to update their load forecasts from the 2019 Integrated Energy Policy Report, as well as a two-month extension of time for LSEs to file their next IRP.

CalCCA's comments and reply comments indicate support the adoption of an RSP that will achieve the state's GHG reduction goals and state that the RPS does not over-rely on solar and storage resources. CalCCA was critical of the SERVVM model, including constraints used on imports, and recommended the CPUC replace it for the next IRP cycle, as well as provide greater flexibility in the aggregation process.

- **Analysis:** The procurement track of this proceeding could potentially diminish VCE's authority and control over its resource procurement decisions, although the scope of centralized procurement is now limited to establishing a procurement backstop mechanism and procurement of resources requiring collective action. Any changes to D.19-11-016 in response to the three applications for rehearing could change the requirement that VCE procure an additional 12.6 MW of incremental procurement over the baseline. With respect to the proposed 2020 RSP, the proceeding is now considering modeling assumptions and outputs that could further impact VCE's 2020 IRP requirements.
- **Next Steps:** Comments including updated load forecasts and reply comments, respectively, are now due February 28 and March 13, 2020.

A Proposed Decision on 2019 Reference System Portfolio and Filing Requirements, with final templates posted to the CPUC website, is anticipated in February 2020.

A progress report on procurement activities stemming from D.19-11-016 is due February 15, 2020. LSEs must also provide progress information and an attestation in their 2020 IRP filings that are now due July 1, 2020, including a list of projects, capacities, online dates, demonstration of incrementality to the baseline, and a description of how they have addressed pollutants in disadvantaged communities. All LSEs must provide electricity resource contract information on May 1 every year (moved to July 1 in 2020).

- **Additional Information:** [Ruling](#) allowing updated load forecasts (January 24, 2020); [Protect Our Communities Application for Rehearing](#) of D.19-11-016 (December 13, 2019); [GenOn Holdings Application for Rehearing](#) of D.19-11-016 (December 13, 2019); [Joint Application for Rehearing](#) of D. 19-11-016(December 5, 2019); [List of Baseline Resources](#) (December 2, 2019); [E-Mail Ruling](#) extending RSP comments deadlines (November 19, 2019); [D.19-11-016](#) (November 13, 2019); [Ruling](#) requesting comments on RSP (November 6, 2019); [Ruling](#) initiating procurement track

(June 20, 2019); [D.19-04-040](#) on 2018 IRPs and 2020 IRP requirements (May 1, 2019); Docket No. [R.16-02-007](#).

## RA Rulemaking (2021-2022)

On January 22, 2020, Commissioner Randolph issued a Scoping Memo and Ruling.

- **Background:** See the RA Rulemaking (2019-2020) proceeding below for additional background information on current RA issues. The preliminary scope of this proceeding includes Local and Flexible RA requirements beginning in 2021, structural program changes, and program refinements. Specifically, it will determine local RA requirements for the 2021-2023 compliance years, including the CAISO's local capacity study, local area aggregation, local RA waivers or adjustments, and the reliability criteria targeted through procurement obligations. It will also establish Flexible RA requirements for the 2021 and 2022 compliance years.
- **Details:** The scoping memo divides the proceeding into four tracks, with Tracks 1 and 2 :
  - Track 1 considers revisions to the RA import rules.
  - Track 2 considers System and Flexible RA requirements for 2021 and Local RA requirements for 2021-2023. It also considers time-sensitive refinements to the RA program, including modifications to the maximum cumulative capacity (MCC) buckets to address increasing reliance on use-limited resources to meet reliability and needs; using a working group process to consider qualifying capacity counting conventions and requirements for hydro resources, hybrid resources, and third-party demand response resources; re-aggregation of the "PG&E Other" area; and changes to the existing penalty structure and waiver process to address potential market power.
  - Track 3 examines the broader RA capacity structure to address energy attributes and hourly capacity requirements, given the increasing penetration of use-limited resources, greater reliance on preferred resources, rolling off of a significant amount of long-term tolling contracts held by utilities, and material increases in energy and capacity prices experienced in California over the past years.
  - Track 4 will consider the 2022 program year requirements for System and Flexible RA, and the 2022-2024 Local RA requirements.
- **Analysis:** Regulatory developments under consideration in this proceeding that may impact VCE's capacity procurement obligations include the consideration of hourly capacity requirements in light of the increasing penetration of use-limited resources; modifications to maximum cumulative capacity buckets and whether the RA program should *cap* use-limited and preferred resources; whether the CPUC should cap imports; the potential expansion of multi-year local forward RA to system or flexible resources; RA penalties and waivers; counting conventions for hydro, hybrid resources, and DR resources; and Marginal ELCC counting conventions for solar, wind and hybrid resources.
- **Next Steps:** In Track 1, Energy Division will issue a report on import RA issues in early February, followed by a workshop on February 14, 2020. The workshop report and/or proposals are due February 28, 2020, and comments on workshop report and/or proposals are due March 6, 2020.  
  
In Track 2, Energy Division will file a proposal on MCC buckets on February 7, and both Energy Division and other Party proposals on other Track 2 issues are due February 21. A workshop, followed by opportunities for comments and reply comments, will occur in March. A working group on Counting Conventions will meet in February and file its report on March 2, followed by opportunities for comments and reply comments, and then a proposed decision issued in May 2020. Flexible and local RA issues will be addressed in April-May, kicking off with the CAISO draft 2021 LCR Report filed on April 1.

In Track 3, proposals from parties and Energy Division are due July 10.

The schedule and scope of issues for Track 4 will be established in a later Scoping Memo.

- **Additional Information:** [Scoping Memo and Ruling](#) (January 22, 2020); [Order Instituting Rulemaking](#) (November 13, 2019); Docket No. [R.19-11-009](#).

## RA Rulemaking (2019-2020)

On January 14, 2020, the Assigned Commissioner issued a Ruling providing Energy Division's State of the Market Resource Adequacy Report, revised to include October-December 2019 data. On January 17, 2020, the CPUC issued D.20-01-004 addressing a September 2019 Motion from a group of solar and storage parties to establish the RA qualifying capacity (QC) of hybrid resources (i.e., storage paired renewables) for both in front of the meter (IFOM) and behind the meter (BTM) configurations.

- **Background:** This proceeding has three tracks, and is currently focused on remaining central buyer issues in Track 2. [Track 1](#) addressed 2019 local and flexible RA capacity obligations and several near-term refinements to the RA program and is closed.

In [Track 2](#), the CPUC adopted multi-year Local RA requirements and declined to adopt a central buyer mechanism (D.19-02-022 issued March 4, 2019). A pending settlement agreement, filed by CalCCA among other parties (but not PG&E), would create an RA Central Procurement Entity ("RA-CPE"), unidentified in the Settlement Agreement, to procure residual collective RA for all CPUC-jurisdictional LSEs that is not met by individual LSEs. Individual LSEs may choose to procure their share of the collective RA requirement, or they may allow the RA-CPE to procure their share on default. Costs will be allocated ex post based on cost causation principles. The Commission has not taken action on the proposed settlement.

In [Track 3](#), D.19-06-026 adopted CAISO's recommended 2020-2022 Local Capacity Requirements and CAISO's 2020 Flexible Capacity Requirements and made no changes to the System capacity requirements. It established an IOU load data sharing requirement, whereby each non-IOU LSE (e.g., CCAs) will annually request data by January 15 and the IOU will be required to provide it by March 1. It also adopted a "Binding Load Forecast" process such that an LSE's initial load forecast (with CEC load migration and plausibility adjustments based on certain threshold amounts and revisions taken into account) becoming a binding obligation of that LSE, regardless of additional changes in an LSE's implementation to new customers.

- **Details:** The updated RA report finds there is currently sufficient capacity on the system, and compliance with RA requirements is possible, but note that the market is tight and that it is expected to continue to tighten. It observed that 20 of the 42 Commission-jurisdictional LSEs – PG&E, SCE, 9 CCAs and 9 ESPs – submitted local waiver requests due to their inability to procure sufficient capacity to meet their 2020- 2022 year ahead local RA requirements in one or more local areas

D.20-01-004 adopted an interim valuation for IFOM resources that have operational restrictions (e.g., a charging restriction), defining QC as the greater of the ELCC-based QC of the intermittent resource, or the QC of the co-located storage device. It found that it would be premature to adopt a QC methodology for BTM resources because these resources currently receive credit as DR and can continue to do so, and creating a QC methodology would require significant revisions the RA program. For hybrid resources without operational restrictions, it found that it is unnecessary to develop a QC methodology because each resource can obtain an individual CAISO resource ID and receive individual QC values. The CPUC will work to refine the method(s) for counting hybrid resources in 2021-2022 RA rulemaking (R.19-11-009).

- **Analysis:** This proceeding affects VCE's Local RA compliance obligations beginning in 2020, for the first time requiring procurement over a three-year period instead of an annual period. The most significant impacts of D.19-10-021 will be felt by CCAs with unspecified imports currently under contract.



The settlement agreement, if approved by the CPUC, would resolve central buyer issues other than the identity of the central buyer. Moving to a central procurement entity as proposed in the settlement agreement would impact VCE's RA procurement and compliance, including eliminating the need for monthly RA showings and associated penalties and/or waiver requests from individual LSEs. VCE could choose to procure its share of RA or allow that to be done by the central buyer and pay for its share of such procurement.

CalCCA's Petition for Modification, if granted, would provide CCAs with the potential for a waiver of system and flexible RA requirements (in addition to the existing waiver process for local RA). The disaggregation of the PG&E Other Zone is likely to complicate VCE's RA procurement efforts, so if the PG&E PFM is approved by the CPUC, it could provide alternative compliance options to VCE and additional flexibility.

- **Next Steps:** The timeline for a final decision regarding the central buyer is unclear.
- **Additional Information:** [D.20-01-004](#) on qualifying capacity value of hybrid resources (January 17, 2020); [Ruling](#) on Energy Division's RA State of the Market Report (January 14, 2020); [D.19-12-064](#) granting motion for stay of D.19-10-021 (December 23, 2019); [Powerex Application for Rehearing](#) of D.19-10-021 (November 18, 2019); [CAISO Application for Rehearing](#) of D.19-10-021 (November 18, 2019); [Petition for Modification](#) of D.19-06-026 by CalCCA (October 30, 2019); [CalCCA Application for Rehearing](#) of D.19-10-021 (October 24, 2019); [D.19-10-021](#) affirming RA import rules (October 17, 2019); [D.19-09-054](#) extending statutory deadline (September 26, 2019); [PG&E PFM](#) regarding PG&E Other disaggregation (September 11, 2019); [Ruling](#) issuing RA State of the Market (September 3, 2019); [Joint Motion](#) to adopt a settlement agreement for a residual central procurement entity (August 30, 2019); [D.19-06-026](#) adopting local and flexible capacity requirements (July 5, 2019); Docket No. [R.17-09-020](#).

## PG&E's Phase 1 GRC

On January 6, 2020, the ALJs issued a Ruling granting a PG&E motion for oral argument. On January 24, 2020, the AHC filed a Motion to withdraw from the proceeding following an agreement it reached with PG&E to support its reorganization plan. On January 27, 2020, PG&E filed a Motion requesting official notice of information in its 10-K Annual Reports showing its total number of electric and gas customers for 2013-2018. Parties filed comments and reply comments, respectively, on January 21, 2020, and February 5, 2020, on the proposed Settlement Agreement. Parties also filed reply briefs on disputed issues outside of the Settlement Agreement on January 27, 2020.

- **Background:** PG&E's three-year GRC covers the 2020-2022 period. For 2020, it has requested an additional \$1.058 billion (from \$8.518 billion to \$9.576 billion), or a 12.4% increase over its 2019 authorized revenue requirement, comprised of increases related to its gas distribution (\$2.097 billion total, or a \$134 million increase), electric distribution (\$5.113 billion total, or a \$749 million increase), and generation (\$2.366 billion total, or a \$175 million increase) services. If approved, it would increase a typical monthly residential electric (500 kWh) and natural gas (34 therms) customer bill by \$10.57, or 6.4%, comprised of an electric bill increase of \$8.73 and a gas bill increase of \$1.84. For 2021 and 2022, PG&E requested total increases of \$454 million and \$486 million, respectively. PGE's GRC does not include a request for cost recovery related to 2017 and 2018 wildfire liabilities.

The Settlement Agreement, filed December 30, 2019, would result in an increase in PG&E's 2020 revenue requirement of \$575 million (*i.e.*, \$483 million lower than PG&E's original request), with additional increases of \$318 million, or 3.5% in 2021, and \$367 million, or 3.9%, in 2022. The Settlement Agreement would result in PG&E withdrawing its proposal for a non-bypassable charge related to its hydroelectric facilities. It would require PG&E to develop new and enhanced reporting to provide increased visibility into the work it performed. It also provides for PG&E's ability to purchase insurance coverage up to \$1.4 billion to protect against wildfire risk and other liabilities, reflected in PG&E's forecast as a cost of \$307 million. The consolidated 2020 electric and gas bill impact would be 3.4%.

- **Details:** N/A.
- **Analysis:** PG&E's GRC proposals include shifting substantial costs associated with its hydroelectric generation from its generation rates (applicable only to its bundled customers) into a non-bypassable charge affecting all of its distribution customers, including VCE customers, which would negatively affect the competitiveness of VCE's rates relative to PG&E's. However, that proposal would be withdrawn if the Settlement Agreement is approved.
- **Next Steps:** The ALJs are expected to issue a proposed decision.
- **Additional Information:** [PG&E Motion](#) for Official Notice of Facts (January 27, 2020); [Joint Motion](#) for Settlement Agreement (January 14, 2020); [E-Mail Ruling](#) granting oral argument (January 6, 2020); [E-Mail Ruling](#) modifying procedural schedule (December 2, 2019); [E-Mail Ruling](#) suspending briefing deadlines (November 25, 2019); [D.19-11-014](#) (November 14, 2019); [Ruling](#) setting public participation hearings (May 7, 2019); [Scoping Memo and Ruling](#) (March 8, 2019); [Joint CCAs' Protest](#) (January 17, 2019); [Application](#) and [PG&E GRC Website](#) (December 13, 2018); Docket No. [A.18-12-009](#).

## PG&E's Phase 2 GRC

On January 10, 2020, parties including a group of northern California CCAs protested PG&E's Phase 2 GRC application. PG&E filed its response on January 21, 2020. A prehearing conference was held January 23, 2020.

- **Background:** PG&E's 2020 Phase 2 General Rate Case (GRC) addresses marginal cost, revenue allocation and rate design issues covering the next three years. PG&E's pending Phase 1 GRC (filed in December 2018 via a separate proceeding) will set the revenue requirement that will carry through to the rates ultimately adopted in this proceeding.

In this proceeding, PG&E seeks modifications to its rates for distribution, generation, and its public purpose program (PPP) non-bypassable charge. PG&E proposes to implement a plan to move all customer classes to their full cost of service over a six-year period (the first three years of which are covered by this GRC Phase 2) via incremental annual steps. PG&E proposes to use marginal costs for purposes of revenue allocation and to adjust distribution one-sixth of the way to full cost of service each year over a six-year transition period.

Of note, PG&E is proposing changes to the DA/CCA event-based fees that were not updated in the 2017 Phase 2 GRC proceeding. In addition, PG&E proposes to remove the PCIA revenue from bundled generation revenue and allocate that cost separately to bundled customers, collecting the PCIA from bundled customers on a non-time differentiated, per-kWh basis (i.e., the same way it is collected from DA/CCA customers). PG&E will continue to display the PCIA with other generation charges on customer bills, but will unbundle the PCIA as part of unbundled charges in each rate schedule.

- **Details:** N/A.
- **Analysis:** This proceeding will impact the transparency between a bundled and unbundled customer's bills and the allocation of PG&E's revenues requirements among Valley's different rate classes. It will also affect distribution and PPP charges paid by VCE customers to PG&E. Further, PG&E includes a cost-of-service study the purpose of which is to establish the groundwork for separating net metering customers into a separate customer class in the utility's next rate case. If PG&E's proposed CCA fee revisions are adopted, it will increase the cost VCE pays to PG&E for various services.
- **Next Steps:** The ALJ is expected to issue a Scoping Memo and Ruling next. PG&E's proposed schedule anticipates a final CPUC Decision in this proceeding in August 2021, with rates not effective until November 2021.

- **Additional Information:** [E-mail Ruling](#) extending Protest deadline (December 3, 2019); [Application](#), [Exhibit \(PG&E-1\): Overview and Policy](#), [Exhibit \(PG&E-2\): Cost of Service](#), [Exhibit \(PG&E-3\): Revenue Allocation, Rate Design and Rate Programs](#), and [Exhibit \(PG&E-4\): Appendices](#) (November 22, 2019); Docket No. [A.19-11-019](#).

## PCIA Rulemaking

Comments and reply comments on Working Group 2's (Prepayment) Final Report were filed by parties on January 6, 2020, and January 13, 2020, respectively. On January 15, 2020, and then again on January 22, 2020, the ALJ issued rulings modifying the procedural schedule to push back the date of Working Group 3's (Portfolio Optimization and Cost Reduction and Allocation and Auction) report and opportunities for comments and replies. On January 21, 2020, the CPUC issued D.20-01-030, which modifies D.18-10-019 (October 2018) and denies requests for its rehearing.

- **Background:** D.18-10-019 was issued on October 19, 2018, in Phase 1 of this proceeding and left the current PCIA in place, maintained the current brown power index, and adopted revised inputs to the benchmarks used to calculate the PCIA for energy RPS-eligible resources and resource adequacy capacity.

Phase 2 relies primarily on a working group process to further develop a number of PCIA-related proposals. Three workgroups examined three issues: (1) issues with the highest priority: Benchmark True-Up and Other Benchmarking Issues; (2) issues to be resolved in early 2020: Prepayment; and (3) issues to be resolved by mid-2020: Portfolio Optimization and Cost Reduction, Allocation and Auction.

- **Details:** D.20-01-030 denies requests for rehearing of D.18-10-019, which were filed by CalCCA, among other parties. Instead, the CPUC only corrects some citations, adds two conclusions of law, and clarifies its statutory authority to require reporting information of ESPs.
- **Analysis:** D.19-10-001 impacted the PCIA VCE's customers pay in 2020. PG&E's implementation of the PCIA cap via the ERRA forecast proceeding and Advice Letter 5624-E would mean that some customer classes could pay an increase in the PCIA that is slightly more than 0.5 cent per kWh and some customer classes could pay slightly less than the 0.5 cent per kWh increase. Advice Letter 5624-E also means the PCIA could increase mid-year if the amount of revenues that would have been collected but for the cap exceeds a certain trigger and threshold amount in what PG&E has called the PCIA Undercollection Balancing Account (PUBA). The PUBA trigger is an outgrowth of D.18-10-019. Phase 2 of this proceeding will further affect the PCIA paid by VCE's customers in future years, as well as other important PCIA issues that could impact CCAs such as prepayment.
- **Next Steps:** A separate PD is anticipated to be issued in early Winter 2019 on the remaining Working Group 1 issues.

Working Group 3 is now directed to file its report by February 21, 2020, with opening and reply comments, respectively, due March 13 and 27, 2020. Motions for an evidentiary hearing are due April 3, 2020, and a proposed decision is expected in Q3 2020.

- **Additional Information:** [Ruling](#) modifying procedural schedule for working group 3 (January 22, 2020); [D.20-01-030](#) denying rehearing of D.18-10-019 as modified (January 21, 2020); [Ruling](#) modifying procedural schedule (January 15, 2020); [Ruling](#) modifying procedural schedule (December 18, 2019); [Working Group 2 Final Report](#) (December 9, 2019); [AL 5705-E](#) (December 2, 2019); [D.19-10-001](#) (October 17, 2019); [AL 5624-E](#) establishing PCIA Undercollection Balancing Account and Trigger Mechanism (August 30, 2019). [Phase 2 Scoping Memo and Ruling](#) (February 1, 2019); [D.18-10-019](#) Track 2 Decisions adopting the Alternate Proposed Decision (October 19, 2018); [D.18-09-013](#) Track 1 Decision approving PG&E Settlement Agreement (September 20, 2018); Docket No. [R.17-06-026](#).

## Direct Access Rulemaking

On January 8, 2020, a workshop was held on an Energy Division study that will inform the CPUC's recommendations to the Legislature on further expanding Direct Access (DA) for nonresidential customers in California. Parties submitted informal comments and reply comments on January 21, 2020, and January 27, 2020, respectively.

- **Background:** Phase 1 issues were resolved on May 30, 2019. For Phase 2 of this proceeding, the CPUC will address the SB 237 mandate requiring the CPUC to, by June 1, 2020, provide recommendations to the Legislature on "implementing a further direct transactions reopening schedule, including, but not limited to, the phase-in period over which further direct transactions shall occur for all remaining nonresidential customer accounts in each electrical corporation's service territory."
- **Details:** The January 8 workshop included discussions of the impacts of nonresidential DA expansion on resource adequacy, RPS compliance, GHG emissions, emissions of criteria pollutants, integrated resource planning, cost shifting, and consumer protections.
- **Analysis:** This proceeding will impact the CPUC's recommendations to the Legislature regarding the potential future expansion of DA in California, including a potential lifting of the existing cap on nonresidential DA transactions altogether. Further expansion of DA in California could result in non-residential customer departures from VCE and make it more difficult for VCE to forecast load and conduct resource planning. CalCCA has argued that further expansion of nonresidential DA is likely to adversely impact attainment of the state's environmental and reliability goals, and will result in cost-shifting to both bundled and CCA customers.
- **Next Steps:** A final study will be published March 9, 2020, with comments and reply comments on the final recommendations due March 30, 2020 and April 9, 2020, respectively. A proposed decision is anticipated for May 22, 2020.
- **Additional Information:** [Amended Scoping Memo and Ruling](#) adding issues and a schedule for Phase 2 (December 19, 2019); Docket No. [R.19-03-009](#); see also [SB 237](#).

## Wildfire Cost Recovery Methodology Rulemaking

No updates this month. An August 7, 2019, PG&E Application for Rehearing remains pending regarding the CPUC's recent Decision establishing criteria and a methodology for wildfire cost recovery, which has been referred to as a "Stress Test" for determining how much of wildfire liability costs that utilities can afford to pay (D.19-06-027).

- **Background:** SB 901 requires the CPUC to determine, when considering cost recovery associated with 2017 California wildfires, that the utility's rates and charges are "just and reasonable." In addition, and notwithstanding this basic rule, the CPUC must "consider the electrical corporation's financial status and determine the maximum amount the corporation can pay without harming ratepayers or materially impacting its ability to provide adequate and safe service."

D.19-06-027 found that the Stress Test cannot be applied to a utility that has filed for Chapter 11 bankruptcy protection (i.e., PG&E) because under those circumstances the CPUC cannot determine essential components of the utility's financial status. In that instance, a reorganization plan will inevitably address all pre-petition debts, include 2017 wildfire costs, as part of the bankruptcy process. The framework proposed for adoption in the PD is based on an April 2019 Staff Proposal, with some modifications. The framework requires a utility to pay the greatest amount of costs while maintaining an investment grade rating. It also requires utilities to propose ratepayer protection measures in Stress Test applications and establishes two options for doing so.

PG&E's application for rehearing challenges the CPUC's prohibition on applying the Stress Test to utilities like itself that have filed for Chapter 11 bankruptcy. PG&E's rationale is that SB 901

requires the CPUC to determine that the stress test methodology to be applied to all IOUs. Several parties filed responses to PG&E’s application for rehearing disagreeing with PG&E.

- **Details:** N/A.
- **Analysis:** This proceeding established the methodology the CPUC will use to determine, in a separate proceeding, the specific costs that the IOUs (other than PG&E) may recover associated with 2017 or future wildfires.
- **Next Steps:** The only matter remaining to be resolved in this proceeding is PG&E’s application for rehearing. This proceeding is otherwise closed.
- **Additional Information:** [PG&E Application for Rehearing](#) (August 7, 2019); [D.19-06-027](#) (July 8, 2019); [Assigned Commissioner’s Ruling](#) releasing Staff Proposal (April 5, 2019); [Scoping Memo and Ruling](#) (March 29, 2019); [Order Instituting Rulemaking](#) (January 18, 2019); Docket No. [R.19-01-006](#). See also [SB 901](#), enacted September 21, 2018.

## Investigation into PG&E’s Organization, Culture and Governance (Safety OII)

No significant updates this month. On January 24, 2020, the AHC filed a Motion to withdraw from the proceeding following an agreement it reached with PG&E to support its reorganization plan.

- **Background:** On December 21, 2018, the CPUC issued a Scoping Memo opening the next phase of an ongoing investigation into whether PG&E’s organizational culture and governance prioritize safety. This current phase of the proceeding is considering alternatives to current management and operational structures for providing electric and natural gas in Northern California.

In June 2019, D.19-06-008 ordered PG&E to report on the safety experience and qualifications of the PG&E Board of Directors and establishes an advisory panel on corporate governance. The brief Decision required PG&E to provide a variety of information on each PG&E and PG&E Corporation Board member involving safety training, related work experience, previous positions held, and current professional commitments.

- **Details:** N/A.
- **Analysis:** This proceeding could have a range of possible impacts on CCAs within PG&E’s territory and their customers, given the broad issues under investigation pertaining to PG&E’s corporate structure and governance.
- **Next Steps:** TBD.
- **Additional Information:** [Ruling](#) on proposals to improve PG&E safety culture (June 18, 2019); [D.19-06-008](#) directing PG&E to report on safety experience and qualifications of board members (June 18, 2019); [Scoping Memo](#) (December 21, 2018); Docket No. [I.15-08-019](#).

## Wildfire Fund Non-Bypassable Charge (AB 1054)

No significant updates this month. On January 24, 2020, the AHC filed a Motion to withdraw from the proceeding following an agreement it reached with PG&E to support its reorganization plan.

- **Background:** This rulemaking implemented AB 1054 and extended a non-bypassable charge on ratepayers to fund the Wildfire Fund. The scope of this proceeding was limited to consideration of whether the CPUC should authorize ratepayer funding of the Wildfire Fund established by AB 1054, enacted in July 2019, via the continuation of an existing non-bypassable charge (Department of Water Resources bond charge) that would have otherwise expired by the end of

2021. On August 26, 2019, the Bankruptcy Court tentatively granted PG&E’s request to participate in the Wildfire Fund.

D.19-10-056, issued in October 2019, approved the establishment of a non-bypassable charge on IOU customers to provide revenue for the newly established state Wildfire Fund pursuant to 2019 AB 1054. The charge will only be assessed on customers of utilities that participate in the Wildfire Fund (i.e., PG&E, SCE, and SDG&E), and will expire at the end of 2035. The Decision also provides that once a large IOU commits to Wildfire Fund participation, it may not later revoke its participation. The annual revenue requirement for the charge among the large IOUs will total \$902.4 million, allocated at \$404.6 million for PG&E, \$408.2 million for SCE, and \$89.6 million for SDG&E. (There is a June 30, 2020, deadline for PG&E to satisfactorily complete its insolvency proceeding under AB 1054, and therefore become eligible to participate in the Wildfire Fund.) The Wildfire Fund NBC will be collected on a \$/kWh basis, with the revenue requirement allocated based on each class's share of energy sales. Residential CARE and medical baseline customers are exempt. The Wildfire Fund NBC cannot take effect until the DWR Bond charge sunsets, which may take place as early as the second half of 2020.

- **Details:** N/A.
- **Analysis:** This proceeding established a new non-bypassable charge on VCE customers beginning as early as the second half of 2020 to fund the Wildfire Fund under AB 1054. Whether customers in PG&E’s territory will be subject to the charge will be determined only after its Bankruptcy proceeding is complete. D.19-10-056 kept the proceeding open to later consider the annual revenue requirement and sales forecast for the Wildfire Fund non-bypassable charge in 2020.
- **Next Steps:** The non-bypassable charge will go into effect as early as the second half of 2020.
- **Additional Information:** [D.19-10-056](#) approving a non-bypassable charge (October 24, 2019); [Scoping Memo and Ruling](#) (August 14, 2019); [Order Instituting Rulemaking](#) (August 2, 2019); Docket No. [R.19-07-017](#). See also [AB 1054](#).

## Other Regulatory Developments

- **CPUC Modifies GRC Filing Schedule:** The CPUC issued [D.20-01-002](#), changing the timing of large IOU general rate case (GRC) filings from a three-year to a four-year cycle (Docket No. [R.13-11-006](#)). The new GRC application filing deadline will be May 15 (instead of September 1 as it is currently) of the year that is two years prior to the test year. As part of the transition to this new GRC cycle, PG&E will file a combined GRC application in June 2021 (2023 test year). PG&E was also directed to combine its currently-separate GRC and Gas Transmission and Storage rate cases into a single rate case application beginning with its 2020 Risk Assessment and Mitigation Phase (RAMP). The Energy Division will hold a workshop or workshops to explore remaining GRC issues, including GRC Phase 2 scheduling.
- **CPUC Approves Changes to SGIP Funding:** On January 27, the CPUC issued [D.20-01-021](#) establishing funding and program design for the 2020-2024 SGIP Program. The Decision stems principally from 2018 SB 700, which authorized the CPUC to extend annual SGIP collections by up to five years from 2020-2024, but also addresses 2019 AB 1144 providing for the use of SGIP funding to benefit customers impacted by PSPS events. The PD authorizes funding of \$166 million annually from 2020-2024. The total amount of funding is broken down into an 83% allocation for battery storage projects (\$675.6 million), a 12% allocation for renewable generation technologies (\$98 million), and a 5% allocation for heat pump hot water heaters (\$40.7 million).

## Glossary of Acronyms

<b>AB</b>	Assembly Bill
<b>AET</b>	Annual Electric True-up
<b>ALJ</b>	Administrative Law Judge
<b>BTM</b>	Behind the Meter
<b>CAISO</b>	California Independent System Operator
<b>CAM</b>	Cost Allocation Mechanism
<b>CARB</b>	California Air Resources Board
<b>CEC</b>	California Energy Commission
<b>CPUC</b>	California Public Utilities Commission
<b>CTC</b>	Competition Transition Charge
<b>DA</b>	Direct Access
<b>GRC</b>	General Rate Case
<b>ELCC</b>	Effective Load Carrying Capacity
<b>ERRA</b>	Energy Resource and Recovery Account
<b>IEPR</b>	Integrated Energy Policy Report
<b>IFOM</b>	In Front of the Meter
<b>IRP</b>	Integrated Resource Plan
<b>IOU</b>	Investor-Owned Utility
<b>LSE</b>	Load-Serving Entity
<b>MCC</b>	Maximum Cumulative Capacity
<b>PABA</b>	Portfolio Allocation Balancing Account
<b>PD</b>	Proposed Decision
<b>PG&amp;E</b>	Pacific Gas & Electric
<b>PFM</b>	Petition for Modification
<b>PCIA</b>	Power Charge Indifference Adjustment
<b>PUBA</b>	PCIA Undercollection Balancing Account
<b>QC</b>	Qualifying Capacity
<b>RA</b>	Resource Adequacy
<b>RDW</b>	Rate Design Window
<b>RPS</b>	Renewables Portfolio Standard
<b>SCE</b>	Southern California Edison
<b>SED</b>	Safety and Enforcement Division (CPUC)
<b>SDG&amp;E</b>	San Diego Gas & Electric
<b>TCJA</b>	Tax Cuts and Jobs Act of 2017
<b>TURN</b>	The Utility Reform Network
<b>UOG</b>	Utility-Owned Generation
<b>WMP</b>	Wildfire Mitigation Plan
<b>WSD</b>	Wildfire Safety Division (CPUC)

**VALLEY CLEAN ENERGY ALLIANCE**

**Staff Report - Item 9**

---

**TO:** VCE Board of Directors

**FROM:** Mitch Sears, Interim General Manager

**SUBJECT:** Recommendation to the Board on AB 1567, SB 378, and SB 804 and SB 917

**DATE:** February 13, 2020

---

**Recommendation:**

1. Support AB 1567.
2. Support SB 378 as amended.
3. Support SB 804 as amended.
4. Support SB 917 in concept.

**Background and Analysis**

On February 5, 2020, the Community Advisory Committee (CAC) received, reviewed and took action in a special meeting supporting the staff recommendations of support positions on the following three (3) bills:

**1. AB 1567 (Aguiar-Curry). Organic waste: scoping plan.**

**Summary:** Would, on or before December 31, 2021, require the Strategic Growth Council, in consultation with stakeholders and relevant permitting agencies, to prepare and submit to the Legislature a report that provides a scoping plan for the state to meet its organic waste, climate change, and air quality mandates, goals, and targets and would require the scoping plan to include, among other things, recommendations on policy and funding support for the beneficial reuse of organic waste.

This bill proposes that the Strategic growth Council, with input from other departments and agencies, create a scoping plan for the state to meet its organic waste, climate change, and air quality goals, mandates, etc. This scoping plan could include innovative strategies for energy generation from organic waste in Yolo County.

Consistent with adopted Board policy relating to time sensitive legislative issues, VCE staff worked with the VCE Board subcommittee to submit a letter supporting AB1567 on January 13, 2020 for the bill's hearing in the Assembly Natural Resources Committee (ANRC). The ANRC, Assembly Appropriations Committee and Assembly Floor unanimously passed this bill.

Staff and the CAC recommend ratification of VCE's support for this legislation.



**2. SB 378 (Wiener) Electrical corporations: deenergization events: procedures: allocation of costs: reports.**

Summary: Would require each electrical corporation to annually submit a report to the wildfire Safety Division and, after June 30, 2021, to the Office of Energy Infrastructure Safety, that includes the age, useful life, and condition of the electrical corporation's equipment, inspection dates, and maintenance records for its equipment, investments to maintain and improve the operation of its transmission and distribution facilities, and an assessment of the current and future fire and safety risk posed by the equipment.

Senator Wiener introduced language proposing stricter oversight and penalties regarding PSPS and then amended the bill in January 2020. The amended bill proposes to require greater information sharing by IOU's with state and local government regarding IOU infrastructure and investments made in the infrastructure; a code of conduct regarding IOU marketing against POU formation/expansion; a code of conduct regarding IOU marketing against microgrids and distributed energy generation; and additional damages due to a PSPS; and a \$500,000 per hour per 50,000 customer penalty for an IOU implementing a PSPS.

Consistent with adopted Board policy relating to time sensitive legislative issues, VCE staff worked with the VCE Board subcommittee to submit a letter supporting AB1567 on January 13, 2020 for the bill's hearing in the Senate Energy Committee. Committee amendments removed the two code of conduct provisions, reduced the penalty amount to \$250,000 per hour per 50,000 customers and requires a finding by the PUC that the IOU failed to act reasonably and prudently in implement the PSPS. The bill has since passed the Senate Appropriations Committee and passed the Senate Floor on a bipartisan vote.

Staff and the CAC recommend ratification of VCE's support for this legislation.

**3. SB 804 (Wiener) Public capital facilities: electric utilities: rate reduction bonds.**

Summary: The Marks-Roos Local Bond Pooling Act of 1985 authorizes certain joint powers authorities, upon application by a local agency that owns and operates a publicly owned utility, defined to mean certain utilities furnishing water or wastewater service to not less than 25,000 retail customers, to issue rate reduction bonds to finance utility projects, as defined, subject to certain requirements. Under the act, these rate reduction bonds are secured by a pledge of utility project property, and the joint powers authority issuing the bonds may impose on, and collect from, customers of the publicly owned utility a utility project charge to finance the bonds, as provided. The act requires the California Pollution Control Financing Authority, among other things, to review each issuance of rate reduction bonds issued under these provisions. This bill would expand the definition of a publicly owned utility for these purposes to include certain utilities furnishing generation transmission, or distribution electrical service to retail customers and would authorize an authority to issue rate reduction bonds to finance or refinance utility projects for the provision of generation, transmission, or distribution electrical service.

SB 804 is a bill produced by SF PUC to provide an additional financing tool to the formation of municipal utilities. This proposed legislation would extend the existing authority to use rate reduction bonds to local power agencies throughout California.

Existing law allows local public agencies to issue rate reduction bonds to finance various water and wastewater infrastructure projects. Investor-owned electric utilities (IOUs), including PG&E, are also able to take advantage of this financing structure, but this mechanism is not available to public electric utilities. Rate reduction bonds are asset-backed securities that save ratepayers significant dollars when local agencies finance infrastructure through this mechanism in two ways.

- 1) securitization allows these agencies to qualify bonds for more favorable credit ratings. If a bond receives a favorable AAA rating, instead of a lower rating, the local agency can borrow funds at an interest rate that is well below the rate that would otherwise apply to the agency's long-term debt, substantially reducing borrowing and benefiting ratepayers.
- 2) Securitization enables publicly-owned utilities to reduce debt.

Staff and the CAC recommend that the Board support this legislation as consistent with VCE's adopted principles on establishment of public power options that deliver cost competitive energy to customers.

#### **Staff's Summary**

The following legislative bill is new and has not been vetted by the CAC; although, it has been discussed by the CAC Legislative/Regulatory Task Group. Staff provides a summary and recommendation below:

#### **4. SB 917 (Wiener) California Consumer Energy and Conservation Financing Authority: eminent domain: Northern California Energy Utility District: Northern California Energy Utility Services.**

**Summary:** Would rename the authority the California Consumer Energy and Conservation Financing Authority and would repeal the prohibition upon the authority approving any new program, enterprise, or project, on or after January 1, 2007. The bill would authorize the authority to acquire, by eminent domain, the assets or ownership of an electrical corporation, gas corporation, or public utility that is both an electrical and gas corporation, including any franchise rights, if that corporation has been convicted of one or more felony criminal violations of laws enacted to protect the public safety within 10 years of the date the eminent domain action is commenced. The bill would authorize a local publicly owned energy utility, as defined, to elect to join in the eminent domain action brought by the authority and acquire that portion of the electrical or gas system necessary to provide service within its borders if the local publicly owned energy utility contributes its proportionate share of the compensation paid for the assets or ownership of the public utility.

Senator Wiener is proposing a public takeover of PG&E, but this is not the co-op proposal that San Jose Mayor Liccardo has been advocating for and that many local elected officials have endorsed. Sen. Wiener is proposing a public-private partnership similar to the Long Island Power Authority model.

The bill would authorize the California Consumer Energy and Conservation Financing Authority to acquire by eminent domain a public utility convicted of a felony within 10 years of the eminent domain proceeding commencing. Local publicly owned energy utilities can join the eminent domain action and

acquire the portion of the electric/gas system needed to provide service within its borders; the publicly owned utility must contribute its proportionate share of the costs of acquiring the system.

The bill would also create the Northern California Energy Utility District, similar in function and power to a municipal utility, and create the Northern California Energy Utility Service, a private public benefit corporation. The district would house the senior management and government/community relations positions to oversee the service, which would house the operating employees.

Other highlights from the bill:

- All labor agreements protected
- 5 year transition to POU structure
- All PGE assets not just electric
- Local jurisdictions who already have expressed POU interest can spin off from the bigger entity within one year.
- Future POU efforts to be evaluated on case by case basis.
- PUC will have no authority over rate setting
- CCAs take over primary procurement authority
- CCAs have right of first refusal for Provider of Last Resort (POLR)

The CAC has not made a recommendation on this bill. Staff is recommending that the Board support this legislation in concept. Due to its complexity and recent introduction, staff is in the process of studying the details of the proposed legislation.

# VALLEY CLEAN ENERGY ALLIANCE

## Staff Report – Item 10

---

**TO:** Valley Clean Energy Alliance Board of Directors  
**FROM:** Mitch Sears, Interim General Manager, VCEA  
**SUBJECT:** Customer Enrollment Update (Information)  
**DATE:** February 13, 2020

---

### RECOMMENDATION

Receive and review the attached Customer Enrollment update as of February 6, 2020.

# Item 14 - Enrollment Update

	Davis	Woodland	Yolo Co	Total	Ag	Commercial	Industrial	Residential
<b>VCEA customers</b>	25,770	18,831	9,277	53,878	1,748	5,748	5	46,377
<b>Eligible customers</b>	26,957	21,324	11,456	59,737	2,013	6,366	6	51,352
<b>Participation Rate</b>	96%	88%	81%	90%	87%	90%	83%	90%

- There are currently 5,802 NEM customers not included in this table. They will enroll throughout the remainder of 2020.

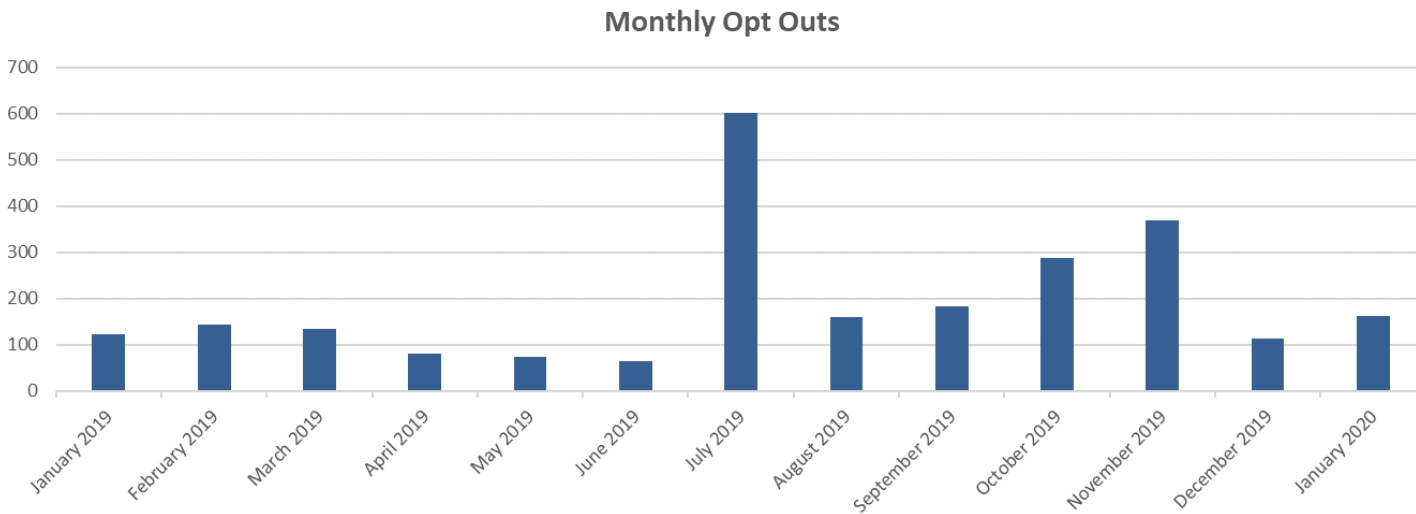

Status Date: 2/6/20



**VALLEY**  
CLEAN ENERGY

# Item 14 - Enrollment Update

181 Opt Ups

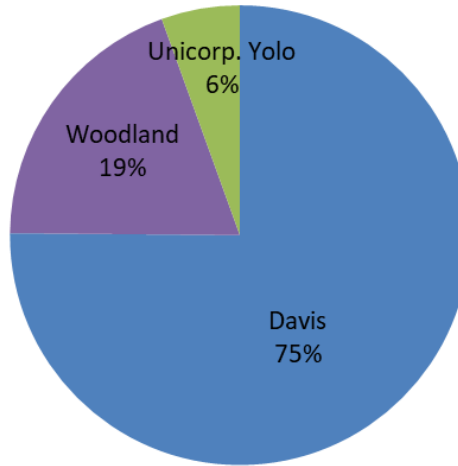

Monthly Opt Ups

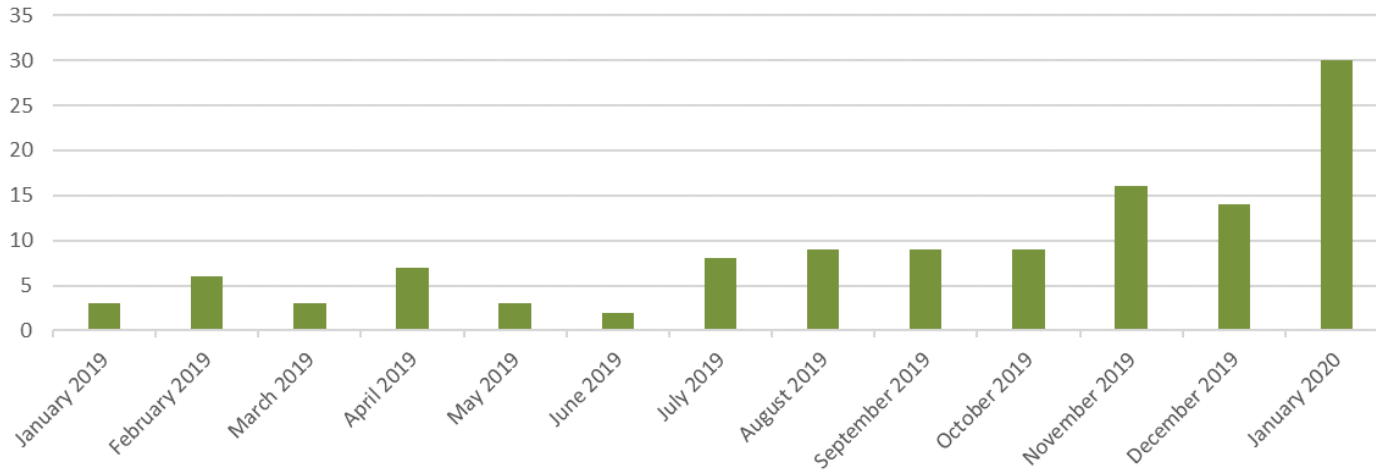

Status Date: 2/6/20



**VALLEY**  
CLEAN ENERGY

**VALLEY CLEAN ENERGY ALLIANCE**

**Staff Report – Item 11**

---

TO: Valley Clean Energy Alliance Board of Directors

FROM: Mitch Sears, Interim General Manager

SUBJECT: Community Advisory Committee January 23, 2020 Meeting Summary

DATE: February 13, 2020

---

This report summarizes the Community Advisory Committee’s meeting held on Thursday, January 23, 2020.

- A. **1/9/20 Board meeting update:** Mr. Sears provided a brief recap of the Board’s 1/9/20 meeting. In addition, Mr. Sears brought up the issue of Power Charge Indifference Adjustment (PCIA) “pays for the attributes” of GHG component of large hydro or nuclear power, but VCE does not benefit from them. The question of whether VCE accepts or rejects these attributes needs to be discussed. It is anticipated that the letter will come out February 1<sup>st</sup> and VCE will have 30 days to respond. This issue will be presented to the Board for their decision. The CAC agreed to hold a special meeting on Wednesday, February 5, 2020 at 2 p.m. to discuss this issue and make a recommendation to the Board.
  
- B. **CAC discussion on Task Groups to determine structure for 2020.** The following Task Groups were formed:
  - Regulatory and Legislative Task Group
  - Outreach Task Group
  - Programs Task Group
  - Strategic Planning Task Group
  - Rates Task Group

Motion passed: 5-0-0

For those members that were not present, staff is to follow up with them individually to ask which task groups they would be interested in being a part of.

- C. **Review of Vision Statement.** It was agreed that the vision statement needs to be reviewed along with long term analysis of the SWOT results. This can be done after the Strategic Plan has been adopted.

- D. **Update on potential acquisition of PG&E's local electricity distribution system.** Mr. Sears provided an update of PG&E's bankruptcy. Interest was expressed in documenting "lessons learned" of the acquisition process in bankruptcy court to be shared with other CCAs.
- E. **Election of Officers.** Yvonne Hunter will serve as Chair and Marsha Baird will serve as Vice Chair. The Secretary position has been eliminated. Motion passed: 5-0-0



## VALLEY CLEAN ENERGY ALLIANCE

### Staff Report – Item 12

---

**TO:** Valley Clean Energy Alliance Board of Directors

**FROM:** Mitch Sears, Interim General Manager

**SUBJECT:** Legal Services – Contract Amendment for Regulatory Legal Services

**DATE:** February 13, 2020

---

#### **RECOMMENDATION**

Adopt a resolution approving an amendment to the legal services agreement with Keyes and Fox for regulatory legal services modifying the terms and timing of the agreement.

#### **BACKGROUND and ANALYSIS**

Valley Clean Energy (VCE), engaged Keyes and Fox (K&F) to provide regulatory legal services in June 2018. The original contract was structured on a calendar year basis through the end of 2019. As with other service contracts, staff is attempting to align them with the fiscal year calendar (July - June), to ease administration and budgetary planning for VCE. In discussions with K&F in late 2019 regarding contract renewal, staff proposed and K&F accepted the concept of a contract extension to June 30, 2020 to align with the fiscal year.

The attached contract amendments provide for this extension with an updated scope of work to include the regulatory filings and CPUC activities that are scheduled for the first half of 2020 (Attachment 3, Scope of Services). The “not to exceed” amounts for the existing scope of work tasks are also reset to account for the additional 6 months of the revised contract (Jan – June 2020). Additionally, the amendments include a cost of living based increase to rates at an average of 5-6% over the 2019 K&F rates (Attachment 5, pg4 – Payment/Rates).

The amendment to the K&F rate schedule and corresponding “not to exceed” amounts for tasks contained in the amended scope of work are within the current fiscal year budget for regulatory legal services (FY 19/20). Note, K&F is performing minor tasks related to PG&E bankruptcy monitoring at the CPUC. As directed by the Board, legal services activities related to the PG&E bankruptcy are accounted for in VCE’s contingency budget for this fiscal year.

#### **CONCLUSION**

The proposed amendments are necessary for VCE’s continuing regulatory compliance activities and staff is recommending approval of the amendments because the rates are competitive with the market, the services delivered continue to be of high quality, and that this action will allow VCE to simplify administration by aligning contracts with VCE’s fiscal year calendar. Therefore,

staff is recommending that the Board approve the modifications included in the attached contract amendments with K&F.

**ATTACHMENTS**

1. Resolution
2. Legal Services Agreement Amendment – K&F
3. Legal Services Agreement Amendment – Exhibit A (Scope of Services)
4. Legal Services Agreement Amendment – Exhibit C (Schedule of Services)
5. Legal Services Agreement Amendment – Exhibit D (Payment and Rates)

Note: no changes are proposed to contract exhibit B.

**VALLEY CLEAN ENERGY ALLIANCE**

**RESOLUTION NO. 2020- \_\_\_\_\_**

**A RESOLUTION OF THE VALLEY CLEAN ENERGY ALLIANCE APPROVING AMENDMENT TWO (2) TO THE KEYES & FOX LLP AGREEMENT FOR REGULATORY COMPLIANCE AND ADVOCACY LEGAL SERVICES AND AUTHORIZING THE VCE INTERIM GENERAL MANAGER TO EXECUTE THE AMENDMENT**

**WHEREAS**, the Valley Clean Energy Alliance (“VCE”) is a joint powers agency established under the Joint Exercise of Powers Act of the State of California (Government Code Section 6500 et seq.) (“Act”), and pursuant to a Joint Exercise of Powers Agreement Relating to and Creating the Valley Clean Energy Alliance between the County of Yolo (“County”), the City of Davis (“Davis”), the City of Woodland and the City of Winters (“Cities”) (the “JPA Agreement”), to collectively study, promote, develop, conduct, operate, and manage energy programs; and,

**WHEREAS**, on June 26, 2018 an agreement was entered into between Valley Clean Energy and Keyes & Fox LLP to provide legal services related to regulatory compliance and regulatory advocacy, expiring December 31, 2018; and

**WHEREAS**, Keyes & Fox LLP also provides regulatory counsel support to CalCCA and other Community Choice Aggregators on joint California Public Utilities Commission filings; and

**WHEREAS**, on January 23, 2019 Amendment One (1) to the Keyes & Fox LLP agreement was approved extending the term through December 31, 2019 and refining the previous scope of services and budget for 2019; and,

**WHEREAS**, to align the contract from a calendar year to a fiscal year (July – June) to ease administration and budgetary planning for VCE, in late 2019, staff proposed and Keyes & Fox LLC accepted the concept of a contract extension to June 30, 2020 to align with the fiscal year; and,

**WHEREAS**, in addition to the contract time extension to align with VCE’s fiscal year, the scope of work and budgeted amounts have been updated to be consistent with the contract extension.

**NOW, THEREFORE**, the Board of Directors of the Valley Clean Energy Alliance hereby authorizes the VCE Interim General Manager, in consultation with VCE Legal General Counsel, to finalize, approve and execute on behalf of VCE Amendment Two (2) to the Keyes & Fox LLC Agreement for regulatory legal services modifying the terms and time of the agreement as set forth in the attached Exhibit A - Amendment Two (2) to Keyes & Fox LLC Agreement.

**PASSED, APPROVED, AND ADOPTED**, at a regular meeting of the Valley Clean Energy Alliance, held on the \_\_\_ day of \_\_\_\_\_ 2020 by the following vote:

AYES:

NOES:

ABSENT:

ABSTAIN:

---

Don Saylor, VCE Chair

---

Alisa M. Lembke, VCE Board Secretary

Attachment: Exhibit A - Amendment Two (2) to Keyes & Fox LLC Agreement

## **Exhibit A**

### **Amendment Two (2) to Keyes & Fox LLC Agreement**

**AMENDMENT NO. TWO (2)**  
**TO THE AGREEMENT FOR CONSULTANT SERVICES**  
**BETWEEN**  
**VALLEY CLEAN ENERGY ALLIANCE**  
**AND**  
**KEYES & FOX LLP**

**1. Parties and Date.**

This Amendment No. Two (2) to the ~~Consultant Services~~ Agreement for Consultant Services is made and entered into as of this 31st~~6th~~ day of January 2019~~20~~, by and between Valley Clean Energy Alliance, a Joint Powers Agency, existing under the laws of the State of California with its principal place of business at 604 2<sup>nd</sup> Street, Davis, California 95616 (“VCEA”) and Keyes & Fox LLP, a Limited Liability Partnership with its principal place of business at 580 California St., 12<sup>th</sup> Floor San Francisco, California 94104 ~~436-14<sup>th</sup> Street, Suite 1305, Oakland, California 94612~~ (“K&F”). VCEA and K&F are sometimes individually referred to as “Party” and collectively as “Parties.”

**2. Recitals.**

2.1 Keyes & Fox LLP. VCEA and K&F have entered into an agreement entitled “Agreement for Consultant Services” dated June 26, 2018 for the purpose of retaining K&F to provide the services described in the Agreement and Amendment No. One to that Agreement dated February 6, 2019. (“collectively referred to as “-Agreement”)

2.2 Amendment Purpose. VCEA and K&F desire to amend the Agreement to extend the Agreement for an additional six months to expire on June 30, 2020 and, therefore, to revise the scope of services, and provide the not-to-exceed compensation amount for the additional six (6) months.

2.3 Amendment Authority. This Amendment No. Two (2) is authorized pursuant to Section 6.10 of the Agreement.

**3. Terms.**

3.1 Amendment. Section 1.4 of the Agreement is hereby amended in its entirety to read as follows:

1.4 Term The term of this Agreement, as amended, shall begin on January 1, 2020 and shall end on June 30, 2020, unless amended as provided in the Agreement, or when terminated as provided in Article 5.

3.2 Amendment. Section 4.1 of the Agreement is hereby amended in its entirety to read as follows:

4.1 Compensation This is a “time and materials” based agreement. Consultant shall receive compensation, including authorized reimbursements, for Services rendered under this Agreement at the rates, in the amounts and at the times set forth in **Exhibit D**. Notwithstanding the provisions of Exhibit D, the total compensation shall not exceed ~~eighty-eight one hundred forty two~~ eighty-eight one hundred ~~thousand~~ threesix hundred and no/100 dollars (~~\$88142,3600~~) without written approval of VCEA. Extra Work may be authorized, as described below, and if authorized, will be compensated at the rates and manner set forth in this Agreement.

3.3 Amendment. Exhibits A, C and D of the Agreement are hereby replaced in their entirety by the Exhibits A, C and D attached hereto, which are incorporated herein.

3.4 Continuing Effect of Agreement. Except as amended by this Amendment No. Two (2), all other provisions of the Agreement remain in full force and effect and shall govern the actions of the parties under this Amendment No. Two (2). From and after the date of this Amendment No. Two (2), whenever the term “Agreement” appears in the Agreement, it shall mean the Agreement as amended by this Amendment No. Two (2).

3.5 Adequate Consideration. The Parties hereto irrevocably stipulate and agree that they have each received adequate and independent consideration for the performance of the obligations they have undertaken pursuant to this Amendment No. Two (2).

3.6 Severability. If any portion of this Amendment No. Two (2) is declared invalid, illegal, or otherwise unenforceable by a court of competent jurisdiction, the remaining provisions shall continue in full force and effect.

**[Signatures on Next Page]**

**SIGNATURE PAGE FOR AMENDMENT NO. ONE (1) TO THE AGREEMENT FOR  
CONSULTANT SERVICES  
BETWEEN VALLEY CLEAN ENERGY ALLIANCE  
AND KEYES & FOX LLP**

IN WITNESS WHEREOF, the Parties have entered into this Amendment No. ~~TWO (2)ONE~~  
(1) as of the ~~31st~~<sup>6<sup>th</sup></sup> day of ~~January, February~~ 2019.

VALLEY CLEAN ENERGY ALLIANCE

KEYES & FOX LLP

By: \_\_\_\_\_  
Mitch Sears  
Interim General Manager

By: \_\_\_\_\_  
Its: \_\_\_\_\_ Partner

~~J. Lindl~~ \_\_\_\_\_

Printed Name: \_\_\_\_\_ ~~Sheridan Pauker~~ ~~Timothy~~

APPROVED AS TO FORM:

By: \_\_\_\_\_  
Harriet Steiner  
VCEA Attorney



**EXHIBIT A**

**SCOPE OF SERVICES**

**Services Keyes & Fox LLP Will Provide**

Task 1: Maintain a calendar of regulatory compliance filing obligations and deadlines and provide a weekly snapshot highlighting upcoming filing dates and responsibilities. The weekly snapshot includes CPUC, CAISO, CEC, CARB, and U.S. EIA compliance deliverables.

Task 2: Review compliance filings after they are prepared by SMUD to ensure they are complete and correct prior to filing. A compliance review will be conducted for the following filings: (1) RPS Compliance Report; (2) Revised 2019 RPS Procurement Plan; (23) 2020 RPS Procurement Plan; (4) 2020 IRP; (35) Month-Ahead Resource Adequacy (RA) templates (12 templates total); (46) Monthly Load Migration Forecast (12 templates total); (57) Year-Ahead System, Local and Flexible RAR compliance showing (6 templates total). Once complete, K&F will submit the (1) RPS Compliance Report and (2) RPS Procurement Plan and (3) IRP filings to appropriate regulatory authorities on behalf of VCE.

Task 3: Support VCEA staff team as its expert regulatory resource by (i) participating in California Community Choice Association's ("CalCCA's") weekly regulatory call to keep abreast of positions and activities and informing VCEA of any proceedings that will directly impact VCE in a way that CalCCA is not directly addressing, (ii) monitoring key regulatory proceedings (initial list in Exhibit A), notifying VCEA in a timely manner of issues arising in those proceedings that will critically impact VCEA, and attending monthly Board Meetings to explain such issues, if necessary, and (iii) drafting monthly informational memos for the Board of Directors covering the key regulatory proceedings and additional proceedings that may have an impact on VCEA's compliance obligations.

Task 4: Review contracts entered between VCEA and SMUD and VCEA and third parties. K&F understands many of the key contracts between VCEA and SMUD have already been executed and that the need for additional contracting with SMUD and third parties will be limited, so K&F proposes setting aside a small portion of the total budget for this item.

An initial list of the key regulatory proceedings at the California Public Utilities Commission discussed above is as follows:

Docket Number	Subject Matter
R.11-05-005	Renewable Portfolio Standard <u>Rulemaking</u>
<u>I.15-08-019</u>	<u>Investigation into PG&amp;E Organization, Culture &amp; Governance</u>
R.16-02-007	Integrated Resource Planning <u>Rulemaking</u>
R.17-06- <del>02605</del>	Power Charge Indifference Adjustment <u>Rulemaking</u>
R.17-09-020	Resource Adequacy <u>Rulemaking (2019 – 2020)</u>
A.17-12-011, <i>et al.</i>	PG&E Rate Design Window Proceeding
<u>R.18-07-003</u>	<u>RPS Rulemaking</u>
A.18-12-009	PG&E Phase I GRC
<del>A.19-06-XXX (TBD)</del>	<del>2020 PG&amp;E Energy Resource and Recovery Account Compliance Proceeding (Filed late February 2019)</del>
<u>R.19-01-006</u>	<u>Wildfire Cost Recovery Methodology Rulemaking</u>
<u>A.19-02-018</u>	<u>2018 PG&amp;E Energy Resource and Recovery Account Compliance Proceeding</u>
<u>R.19-03-009</u>	<u>Direct Access Rulemaking</u>
A.19-06- <del>001XXX</del> (TBD)	2020 PG&E Energy Resource and Recovery Account Forecast Proceeding ( <u>Filed June 1, 2018</u> )
<u>I.19-06-015</u>	<u>Investigation into PG&amp;E Violations Related to Wildfires</u>
<del>R.18-10-007</del>	<del>Utility Wildfire Mitigation Plan</del>
<del>A.18-11-018</del>	<del>PG&amp;E 2019 Rate Design Window</del>
<del>I.15-08-019</del>	<del>PG&amp;E Organization Culture &amp; Governance</del>
<del>A.19-08-XXX (TBD)</del>	<del>PG&amp;E Phase II GRC (c. Aug. 2019)</del>
<del>R.19-XX-XXX (TBD)</del>	<del>IRP Rulemaking (New Docket)</del>
<del>R.19-01-XXX (TBD)</del>	<del>Wildfire Cost Recovery Rulemaking (c. Jan 2019)</del>
<u>R.19-07-017</u>	<u>Wildfire Fund Non-Bypassable Charge (AB 1054) Rulemaking</u>
<u>I.19-09-016</u>	<u>Investigation of PG&amp;E Bankruptcy Plan</u>
<u>R.19-11-009</u>	<u>Resource Adequacy Rulemaking (2021-2022)</u>
<u>A.19-11-019</u>	<u>PG&amp;E Phase II GRC</u>
<u>R.20-XX-XXX (TBD)</u>	<u>IRP Rulemaking (New Docket)</u>
<u>A.20-XX-XXX (TBD)</u>	<u>2021 PG&amp;E Energy Resource and Recovery Account Forecast Proceeding (c. February 2020)</u>

Docket Number	Subject Matter
<u>A.20-XX-XXX (TBD)</u>	<u>2019 PG&amp;E Energy Resource and Recovery Account Compliance Proceeding (c. June 2020)</u>

Note re Regulatory Advocacy: Since the vast majority of VCEA’s advocacy in proceedings before regulators is anticipated to be through CalCCA and others during ~~2020~~2019, the need for drafting of motions for party status, pleadings, ~~responses to~~ discovery requests or responses thereto, comments related to compliance filings, or Advice Letters; conducting significant legal or policy research; reviewing or providing feedback to VCEA on CalCCA or other CCA joint filings; attending CalCCA-related calls other than the monthly regulatory call; or attending hearings, workshops or meetings with regulators is anticipated to be very limited at this time. For example, the tasks above do not include the drafting of testimony, reply testimony, briefs or hearing attendance in the PG&E Bankruptcy OII docket (I.19-09-016)~~responses to discovery requests or the filing of individual VCEA comments in the Power Charge Indifference Adjustment docket (R.17-06-026)~~. To the extent VCEA requires such work, that work, and any associated expenses, travel, and time spent filing and serving documents, shall be considered “Extra Work” pursuant to Section 4.5 of this Agreement and invoiced at the hourly rates listed in Exhibit D.

## EXHIBIT C

### SCHEDULE OF SERVICES

The scope of this contract commences on January 1, 202019 and runs through June 30~~December 31~~, 202019. The schedule may be extended by mutual agreement in writing by both parties.

EXHIBIT C

## **EXHIBIT D**

### **PAYMENT**

Subject to adjustments necessary for the minimum set fee related to Task 3 and the do-not-exceed levels related to Tasks 1-4 (“Do-Not-Exceed”) below, all work will be performed at the hourly billing rates set forth below as “Keyes & Fox LLP 20~~2019~~ Hourly Rates”.

Keyes & Fox LLP (“K&F”) will invoice Valley Clean Energy Alliance (“VCEA”) monthly. K&F will keep an hourly total of any time spent on VCEA matters. K&F invoices will list the matter worked on and provide information on the dates of service, time involved, attorney or other personnel responsible and activity undertaken. Any unpaid amounts after forty-five (45) days will accrue interest at a rate of nine percent (9%) per annum. All fees for services will be earned as of the time of invoicing.

Expenses, travel time, and time for filing and service are included in the fee structure outlined below unless they are associated with “Extra Work” pursuant to Section 4.5 of this Agreement and, in that case, will be billed at cost (for expenses) or at the billable rates below (for time spent travelling, filing and serving).

Services Keyes & Fox LLP Will Provide	Fee Structure
<p><u>Task 1:</u> Maintain a calendar of regulatory compliance filing obligations and deadlines and provide a weekly snapshot highlighting upcoming filing dates and responsibilities. The weekly snapshot includes CPUC, CAISO, CEC, CARB, and U.S. EIA compliance deliverables.</p>	<p>Billed hourly with a Do-Not-Exceed for <u>Q1 and Q2</u> 2019 of <del>\$36,360</del></p>
<p><u>Task 2:</u> Review compliance filings after they are prepared by SMUD to ensure they are complete and correct prior to filing. A compliance review will be conducted for the following filings: (1) RPS Compliance Report; <u>(2) Revised 2019 RPS Procurement Plan; (3) 2020 RPS Procurement Plan; (4) 2020 IRP(2) RPS Procurement Plan;</u> <del>(53)</del> Month-Ahead Resource Adequacy (RA) templates (12 templates total); <del>(64)</del> Monthly Load Migration Forecast (12 templates total); <del>(75)</del> Year-Ahead System, Local and Flexible RAR compliance showing (6 templates total). Once complete, K&amp;F will submit the (1) RPS Compliance Report <del>and</del> (2) RPS Procurement Plan <u>and (3) IRP</u> filings to appropriate regulatory authorities on behalf of VCE.</p>	<p>Billed hourly with a Do-Not-Exceed for <u>Q1 and Q2 of 2020</u> of <del>\$240,000</del></p>
<p><u>Task 3:</u> Support VCEA staff team as its expert regulatory resource by (i) participating in California Community Choice Association’s (“CalCCA’s”) weekly regulatory call to keep abreast of positions and activities and informing VCEA of any proceedings that will directly impact VCE in a way that CalCCA is not directly addressing, (ii) monitoring key regulatory proceedings (initial list in Exhibit A), notifying VCEA in a timely manner of issues arising in those proceedings that will critically impact VCEA, and attending monthly Board Meetings to explain such issues, if necessary, and (iii) drafting monthly informational memos for the Board of Directors covering the key regulatory proceedings and additional proceedings that may have an impact on VCEA’s compliance obligations.</p>	<p><del>\$67,000</del>/month minimum set fee with (a) time spent above the <del>\$67,000</del> billed hourly and (b) an aggregate Do-Not-Exceed for <u>Q1 and Q2 of 2020</u> for Task 4 of <del>\$60115,000</del></p>

Services Keyes & Fox LLP Will Provide	Fee Structure
<p><u>Task 4</u>: Review contracts entered between VCEA and SMUD and VCEA and third parties. K&amp;F understands many of the key contracts between VCEA and SMUD have already been executed and that the need for additional contracting with SMUD and third parties will be limited, so K&amp;F proposes setting aside a small portion of the total budget for this item.</p>	<p>Billed hourly with a Do-Not-Exceed <u>for Q1 and Q2 of 2020 of \$511,000</u></p>

Note re Regulatory Advocacy: Since the vast majority of VCEA’s advocacy in proceedings before regulators is anticipated to be through CalCCA and others during 2020, the need for drafting of motions for party status, pleadings, ~~responses to~~ responses to discovery requests or responses thereto, comments related to compliance filings, or Advice Letters; conducting significant legal or policy research; reviewing or providing feedback to VCEA on CalCCA or other CCA joint filings; attending CalCCA-related calls other than the monthly regulatory call; or attending hearings, workshops or meetings with regulators is anticipated to be very limited at this time. For example, the tasks above do not include the drafting of testimony, reply testimony, briefs or hearing attendance responses to discovery requests or the filing of individual VCEA comments in the PG&E Bankruptcy Oil Power Charge Indifference Adjustment docket (IR.197-096-0126). To the extent VCEA requires such work, that work, and any associated expenses, travel, and time spent filing and serving documents, shall be considered “Extra Work” pursuant to Section 4.5 of this Agreement and invoiced at the hourly rates listed herein.

K&F and VCEA will review the Do-Not-Exceed amounts set forth above upon a request from either VCEA or K&F for such a review. Any changes to the Do-Not-Exceed amounts resulting from such review shall not affect the amount of any fees already earned.

## Keyes & Fox LLP 2020~~19~~ Hourly Rates

It is K&F's policy to adjust hourly rates for all personnel at the beginning of the calendar year. Rates quoted here are 20~~2019~~ rates.

### ATTORNEYS

<u>Kevin Fox</u>	<u>360</u>
<u>Tim Lindl</u>	<u>295</u>
<u>Sheridan Pauker</u>	<u>350*</u>
<u>Scott Dunbar</u>	<u>245</u>
<u>Julia Kantor</u>	<u>225</u>
<u>Melissa Birchard</u>	<u>220</u>
<u>Beren Argetsinger</u>	<u>210</u>

\*\$385 for compliance/transactional matters

### NON-ATTORNEYS

<u>Miriam Makhyoun</u>	<u>185/260**</u>
<u>Amanda Vanega</u>	<u>180</u>
<u>Justin Barnes</u>	<u>180/260**</u>
<u>Charlie Coggeshall</u>	<u>180</u>
<u>Ben Inskeep</u>	<u>145/200**</u>
<u>Blake Elder</u>	<u>120</u>
<u>Vanessa Luthringer</u>	<u>95</u>
<u>Alicia Zaloga</u>	<u>90</u>

\*\* expert witness rates

### ATTORNEYS

<u>Kevin Fox</u>	<u>340</u>
<u>Tim Lindl</u>	<u>275</u>
<u>Sheridan Pauker</u>	<u>330</u>
<u>Scott Dunbar</u>	<u>220</u>
<u>Beren Argetsinger</u>	<u>200</u>

### NON-ATTORNEYS

<u>Amanda Vanega</u>	<u>170</u>
<u>Justin Barnes</u>	<u>170</u>



<b>Chelsea Barnes</b>	<b>160</b>
<b>Laurel Passera</b>	<b>140</b>
<b>Ben Inskeep</b>	<b>135</b>
<b>Blake Elder</b>	<b>110</b>
<b>Vanessa Luthringer</b>	<b>90</b>

## VALLEY CLEAN ENERGY ALLIANCE

### Staff Report – Item 13

---

**TO:** Valley Clean Energy Alliance Board of Directors

**FROM:** Mitch Sears, Interim General Manager

**SUBJECT:** Legal Services – Contract Amendment for General Counsel Services

**DATE:** February 13, 2020

---

#### **RECOMMENDATION**

Adopt a resolution approving an amendment to the legal services agreement with Best, Best & Krieger for co-general counsel services modifying the terms and timing of the agreement.

#### **BACKGROUND and ANALYSIS**

Valley Clean Energy (VCE), began its pre-launch feasibility phase in 2015/16 with legal services provided jointly by the two entities involved in the formation of the CCA at that time: Yolo County and the City of Davis. Each provided strengths and depth of subject matter such as JPA formation, countywide perspective, utility formation (e.g. Clean Water District), electricity utility formation (e.g. SMUD annexation), and experience during PG&E's 2001/02 bankruptcy. VCE's legal services needs have evolved but are still well served by the joint approach and are specifically managed to minimize duplicative efforts.

In June 2019 the Board approved retaining the co-general counsel approach for legal services and continued the contracts and terms with Best, Best & Krieger (BBK) and the Yolo County Counsel's Office. At that time, BBK informed staff that the rate in the existing contract was below its standard rate for public entities (\$325/hr). In late 2019, BBK approached staff to revisit the VCE contract rate (\$213/hr) to bring it closer in line with its public entity rate. After discussion, BBK agreed to a rate similar to its City Attorney rate for the City of Woodland (~\$250/hr). BBK also agreed to a step approach for the first half of 2020 to \$235/hr, increasing to \$250/hr at the beginning of the new fiscal year in July 2020.

The amendment to the BBK rate is within the current fiscal year budget for general counsel legal services. As directed by the Board, BBK's activities related to the PG&E bankruptcy are accounted for in VCE's contingency budget for this fiscal year.

#### **CONCLUSION**

Staff believes that these modified rates are favorable in the market for CCA general counsel legal services and that the quality of the general counsel legal services provided continues to be high. Therefore, staff is recommending that the Board approve the rate modifications included

in the attached amended contract with BBK, retroactive to January 1, 2020. Note: no modifications are proposed for the contract with County Counsel's office.

**ATTACHMENTS**

1. Resolution
2. Legal Services Agreement Amendment – BBK

**VALLEY CLEAN ENERGY ALLIANCE**

**RESOLUTION NO. 2020- \_\_\_\_\_**

**A RESOLUTION OF THE VALLEY CLEAN ENERGY ALLIANCE APPROVING AMENDMENT ONE (1) TO THE BEST, BEST & KRIEGER AGREEMENT FOR CO-GENERAL COUNSEL LEGAL SERVICES AND AUTHORIZING THE VCE INTERIM GENERAL MANAGER TO EXECUTE THE AMENDMENT**

**WHEREAS**, the Valley Clean Energy Alliance (“VCE”) is a joint powers agency established under the Joint Exercise of Powers Act of the State of California (Government Code Section 6500 et seq.) (“Act”), and pursuant to a Joint Exercise of Powers Agreement Relating to and Creating the Valley Clean Energy Alliance between the County of Yolo (“County”), the City of Davis (“Davis”), the City of Woodland and the City of Winters (“Cities”) (the “JPA Agreement”), to collectively study, promote, develop, conduct, operate, and manage energy programs; and,

**WHEREAS**, in June 2019 an agreement was entered into between VCE and Best, Best & Krieger (“BBK”) for continued legal services as VCE’s general co-counsel with Yolo County Counsel’s Office; and,

**WHEREAS**, BBK informed staff that the rate in the existing contract was below its standard rate for public entities; and,

**WHEREAS**, to bring the existing contract rate closer in line with the market for CCA general counsel legal services and BBK’s public entity rate, a step approach to increase the hourly rate was proposed.

**NOW, THEREFORE**, the Board of Directors of the Valley Clean Energy Alliance hereby authorizes the VCE Interim General Manager to execute on behalf of VCE Amendment One (1) to the Best, Best & Krieger Agreement for legal services modifying the terms, retroactive to January 1, 2020, as set forth in the attached Exhibit A - Amendment One (1) to Best, Best & Krieger Agreement.

**PASSED, APPROVED, AND ADOPTED**, at a regular meeting of the Valley Clean Energy Alliance, held on the \_\_\_\_ day of \_\_\_\_\_ 2020 by the following vote:

- AYES:
- NOES:
- ABSENT:
- ABSTAIN:

\_\_\_\_\_  
Don Saylor, VCE Chair

\_\_\_\_\_  
Alisa M. Lembke, VCE Board Secretary

## **Exhibit A**

### **Amendment One (1) to Best, Best & Krieger Agreement**

**AMENDMENT NO. ONE (1)**  
**TO THE LEGAL SERVICES AGREEMENT**  
**BETWEEN**  
**VALLEY CLEAN ENERGY ALLIANCE**  
**AND**  
**BEST BEST & KRIEGER, LLP**

**1. Parties and Date.**

This Amendment No. One (1) to the Legal Services Agreement is made and entered into as of this **13th day of February 2020**, by and between Valley Clean Energy Alliance, a Joint Powers Agency, existing under the laws of the State of California (“VCEA”) and Best Best & Krieger, LLP, a Limited Liability Partnership (“BB&K”). VCEA and BB&K are sometimes individually referred to as “Party” and collectively as “Parties.”

**2. Recitals.**

2.1 . VCEA and BB&K entered into a legal services agreement effective June 1, 2019 for the purpose of retaining BB&K to provide legal services described in the Agreement and to serve as Co-General counsel to VCEA. (“the “ Agreement”)

2.2 Amendment Purpose. VCEA and BB&K desire to amend the Agreement to revise the hourly rate for legal services under the Agreement.

**3. Terms.**

3.1 Amendment. The section of the Agreement entitled “Your Obligations about Fees and Billings” is hereby amended in its entirety to read as follows:

YOUR OBLIGATIONS ABOUT FEES AND BILLINGS

We have already discussed the fee arrangement with you. We will continue to represent VCEA at the rate of ~~\$213~~ **\$235/hour from January 1, 2020 until July 1, 2020 and the rate of \$250/hour thereafter until July 1, 2020 and the rate of \$250/hour thereafter** for general counsel work. Absent our request and your consent to a different fee structure, this fee will adjust by the change in the cost of living or CPI on July 1 of each year, **beginning on July 1, 2021.**

To the extent that VCEA requires any additional specialized work (such as pension or personnel work), we will notify you and that work will be at the then current public agency standard rates for the attorney doing the work. Standard public agency rates currently range from \$225 to ~~\$450~~ ~~\$495~~ per hour. As we discussed, BBK reviews its rates periodically. Should BBK desire a fee increase or modification in the future, we will contact you and discuss the proposed revised rates with you before implementing any change.

Attached to this letter is a memorandum that describes the other aspects of our firm's billing policies. You should consider this memorandum part of this agreement as it binds both of us. For that reason, you should read it carefully.

3.4 Continuing Effect of Agreement. Except as amended by this Amendment No. One (1), all other provisions of the Legal Services Agreement remain in full force and effect and shall govern the actions of the parties. From and after the date of this Amendment No. One (1) whenever the term “Agreement” appears in the Agreement, it shall mean the Agreement as amended by this Amendment No. One (1).

3.6 Severability. If any portion of this Amendment No. One (1) is declared invalid, illegal, or otherwise unenforceable by a court of competent jurisdiction, the remaining provisions shall continue in full force and effect.

**[Signatures on Next Page]**

**SIGNATURE PAGE FOR AMENDMENT NO. ONE (1) TO THE AGREEMENT FOR  
CONSULTANT SERVICES  
BETWEEN VALLEY CLEAN ENERGY ALLIANCE  
AND BEST BEST & KRIEGER, LLP**

IN WITNESS WHEREOF, the Parties have entered into this Amendment No. ONE (1) as of  
the \_\_ day of February 2020.

VALLEY CLEAN ENERGY ALLIANCE

BEST BEST & KRIEGER, LLP

By: \_\_\_\_\_  
Mitch Sears  
Interim General Manager

By: \_\_\_\_\_  
Its: \_\_\_\_\_ Partner

Printed Name: \_\_\_\_\_

APPROVED AS TO FORM:

By: \_\_\_\_\_  
Eric May  
VCEA Attorney



# VALLEY CLEAN ENERGY ALLIANCE

## Staff Report – Item 14

---

To: Valley Clean Energy Alliance Board of Directors

From: Mitch Sears, Interim General Manager

Subject: Approval of Amendments to Task Orders of the SMUD Professional Services Agreement

Date: February 13, 2020

---

### RECOMMENDATION

Adopt a resolution:

- 1) Approving Amendment 15 to Task Order 4 (operational staff services) and authorizing the Interim General Manager to sign the Amendment on behalf of VCE; and,
- 2) Ratifying the Interim General Manager's approval and execution of Amendment 14 to Task Order 3 (wholesale energy services).

### BACKGROUND AND ANALYSIS

On October 12, 2017 the VCE Board approved a Professional Services Agreement with the Sacramento Municipal Utility District (SMUD) and Task Orders 1 and 2 to provide program launch and operational services. Soon thereafter, a series of additional Task Orders were added to the Agreement, including Task Order 3 to provide Wholesale Energy Services and Task Order 4 to provide Operational Staff Services to VCE.

As VCE progresses through Fiscal Year (FY) 2019/2020, VCE's budgeted approach to the Power Director role has evolved. The Proxy Power Director provided by SMUD announced his pending retirement and VCE acknowledged the importance of bringing that function in house. The impact to costs will need to be adjusted in the operational budget to reflect the change from SMUD providing this service to VCE hiring a Power Director.

#### Task Order 3 (Wholesale Energy Services):

Amendment 14 to SMUD agreement Task Order 3 (wholesale energy services) extends SMUD's credit support services to the end of 2023. The scope of credit support and \$0.80 per MWh fee are unchanged. The original contract period was five years from VCE's June 2018 launch, resulting in a May 31, 2023 end date. The urgency of extending credit services at this time is due to a new three year ahead resource adequacy (RA) compliance obligation implemented by the CPUC in late 2019. VCE is obligated to procure a subset of its estimated RA volume three years in advance, meaning that by October 2020, VCE must demonstrate it has procured the 2023 RA compliance obligation. Due to current RA market conditions, time is of the essence to get the SMUD credit services extension in place so that SMUD was authorized to begin 2023 RA procurement on VCE's behalf. The estimated cost to extend the credit support services by 6 months to the end of 2023 is less than \$30,000. Therefore, due to the time sensitive nature

of the RA procurement, the Interim General Manager, after consulting with VCE legal counsel, signed in accordance with his contract delegation authority from the Board. The requested action is a Board ratification of his signature to extend the credit support services by 6 months.

Task Order 4 (Operational Staff Services):

Amendment 15 to SMUD agreement Task Order 4 (operational services staff) modifies the scope of SMUD's Proxy Power Director obligation. Effective December 20, 2019, SMUD is no longer providing VCE's Proxy Power Director. The original scope is replaced with a transitional support scope during VCE's transition to an in-house Power Director. As VCE now has a Power Director in-house, SMUD subject matter experts will continue to provide transitional support to the new Power Director as needed for a period of time, at the hourly rates defined in Task Order 4.

**FINANCIAL IMPACT**

The elimination of the Proxy Power Director role reduces VCE's expenditure with SMUD by the \$16,150 monthly fixed fee. This cost reduction is offset by the staffing cost to hire the Power Director as a VCE employee, as well as a temporary SMUD cost for as-needed transitional support.

The credit services support extension, at a cost of \$0.80 per MWh derated by the percent of contracts that VCE procures in their name, is estimated to increase VCE's credit support costs less than \$30,000, payable in the month of energy deliveries in 2023. To the degree that SMUD procures additional 2023 energy products on VCE's behalf, the credit support cost will increase.

The anticipated power cost changes will be budgeted in the FY2020/2021 draft operating budget, which will be presented to the Board for final approval at the June 11, 2020 meeting. The credit support cost change will be factored into the FY2023/24 budget.

**CONCLUSION**

Staff is recommending the VCE Board adopt the attached resolution 1) approving Amendment 15 to Task Order 4 (operational staff services) and authorizing the Interim General Manager to sign the Amendment on behalf of VCE and 2) ratifying the Interim General Manager's approval and execution of Amendment 14 to Task Order 3 (wholesale energy services).

**Attachments:**

1. Resolution approving Amendment 15 to Task Order 4 (operational staff services) and authorizing the Interim General Manager to sign the Amendment on behalf of VCE and ratifying the Interim General Manager's approval and execution of Amendment 14 to Task Order 3 (wholesale energy services).
2. Amendment 14 to Task Order 3 (Wholesale Energy Services)
3. Amendment 15 to Task Order 4 (Operational Staff)

**VALLEY CLEAN ENERGY ALLIANCE**

**RESOLUTION NO. 2020-\_\_\_**

**A RESOLUTION OF THE VALLEY CLEAN ENERGY ALLIANCE  
RATIFYING THE INTERIM GENERAL MANAGER’S APPROVAL AND EXECUTION OF  
AMENDMENT 14 TO TASK ORDER 3 AND APPROVING AMENDMENT 15 TO TASK  
ORDER 4 AND AUTHORIZING THE INTERIM GENERAL MANAGER TO SIGN THE  
AMENDMENT ON BEHALF OF VALLEY CLEAN ENERGY TO THE SACRAMENTO  
MUNICIPAL UTILITIES DISTRICT PROFESSIONAL SERVICES AGREEMENT**

**WHEREAS**, the Valley Clean Energy Alliance (“VCE”) is a joint powers agency established under the Joint Exercise of Powers Act of the State of California (Government Code Section 6500 et seq.) (“Act”), and pursuant to a Joint Exercise of Powers Agreement Relating to and Creating the Valley Clean Energy Alliance between the County of Yolo (“County”), the City of Davis (“Davis”), the City of Woodland and the City of Winters (“Cities”) (the “JPA Agreement”), to collectively study, promote, develop, conduct, operate, and manage energy programs; and,

**WHEREAS**, on August 31, 2017, the VCEA Board considered a proposal by the Sacramento Municipal Utilities District (“SMUD”) to provide program launch and operational services and subsequently directed VCEA staff to negotiate a services agreement between VCEA and SMUD for consideration and action by the VCEA Board; and,

**WHEREAS**, on September 21, 2017, the SMUD Board of Directors authorized its CEO to enter into a contract with VCE to provide Community Choice Aggregate support services; and,

**WHEREAS**, on November 16, 2017 the VCE Board approved Task Order 3 to provide Wholesale Energy Services consistent with the SMUD proposal and VCE Board direction; and,

**WHEREAS**, in May 2018 Amendment 2 to Task Order 3 was approved to include the record-keeping to support Green-e certification and set compensation for said services; and,

**WHEREAS**, in April 2019 Amendment 9 to Task Order 3 was approved updating the Integrated Resource Plan and set compensation for said services; and,

**WHEREAS**, on December 12, 2017, the VCE Board approved Task Order 4 to provide Operational Staff Services to VCE for program launch and operations; and,

**WHEREAS**, Task Order 4 was set to expire February 28, 2019 and Interim General Manager Mitch Sears signed Amendment 7 to Task Order 4 extending the term to June 30, 2019; and,

**WHEREAS**, in October 2018 Amendments 3 and 5 to Task Order 4 were approved adding scope of services related to power purchase agreements and designating an On-call Proxy Power

Director, and set compensation for said services;

**WHEREAS**, in December 2018 Amendment 6 to Task Order 4 was approved extending dedicated operational staff through February 28, 2019; and,

**WHEREAS**, in February 2019 Amendment 7 to Task Order 4 was approved extending dedicated operational staff through June 30, 2019; and,

**WHEREAS**, in April 2019 Amendment 8 to Task Order 4 was approved 1) extending dedicated operational staff and the Power Director through June 30, 2020, 2) replacing sub-section 4.2.1 term and termination notification, and 3) increasing the fixed fee for operational staff effective July 1, 2019; and,

**WHEREAS**, in August 2019, Amendment 13 to Task Orders 3 and 4 was approved updating compensation for services and extending the term through June 30, 2020; and,

**WHEREAS**, due to current Resource Adequacy (“RA”) market conditions, time was of the essence to get the SMUD credit services extension in place so that SMUD was authorized to begin 2023 RA procurement on VCE’s behalf, Interim General Manager signed Amendment 14 to Task Order 3 amends Section 3, Term and Termination, to 1) extend the term from May 31, 2023, to December 31, 2023 only as related to the services provided in accordance with Section 1.13, Credit Support Services and 2) all other services will terminate on May 31, 2023, unless mutually agreed to in writing by the Parties; and,

**WHEREAS**, Amendment 15 to Task Order 4 cancels the On-call Proxy Power Director effective December 20, 2019, adds scope of services to transition the Power Proxy Director to a VCEA employee, and updates compensation for services to an hourly rate for professional services.

**NOW, THEREFORE**, the Board of Directors of the Valley Clean Energy Alliance resolves as follows:

1. ratify the Interim General Manager’s approval and execution of Amendment 14 to Task Order 3 (wholesale energy services).
2. approve Amendment 15 to Task Order 4 (operational staff services) and authorize the Interim General Manager to sign the Amendment on behalf of VCE.

**PASSED, APPROVED, AND ADOPTED,** at a regular meeting of the Valley Clean Energy Alliance, held on the \_\_\_\_ day of \_\_\_\_\_ 2020, by the following vote:

AYES:

NOES:

ABSENT:

ABSTAIN:

---

Don Saylor, VCE Chair

---

Alisa M. Lembke, VCEA Board Secretary

EXHIBIT A - Amendment 14 to Master Professional Services Agreement Task Order 3  
Amendment 15 to Master Professional Services Agreement Task Order 4

**EXHIBIT A**

**Amendment 14 to Master Professional Services Agreement Task Order 3**

**Amendment 15 to Master Professional Services Agreement Task Order 4**

**AMENDMENT 14 TO EXHIBIT A: Scope of Services****A.4 Task Order 3 – Wholesale Energy Services**

SMUD and VCEA agree to the following services, terms, and conditions described in this Amendment 14 to Exhibit A, Task Order No. 3 (Amendment 14), the provisions of which are subject to the terms and conditions of the Master Professional Services Agreement (Agreement) between the Parties. If any specific provisions of this Amendment 14 conflict with any general provisions in the Agreement or Task Orders 4, the provisions of this Amendment 14, shall take precedence. Capitalized terms used in this Amendment which are not defined in this Amendment will have the respective meanings ascribed to them in the Agreement or a previous Amendment thereof.

1. Task Order 3, Section 3, *Term and Termination*, is amended to add the following:
  - a. The Term of Task Order 3 is extended from May 31, 2023, to December 31, 2023 only as related to the services provided in accordance with Section 1.13, Credit Support Services.
  - b. All other services will terminate on May 31, 2023, unless mutually agreed to in writing by the Parties.

(Signature page follows)

**SIGNATURES**

The Parties have executed this Amendment 14, and it is effective as of the date of last signature below.

**Valley Clean Energy Alliance**

By:

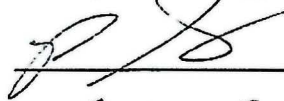
  
\_\_\_\_\_

Name:

MITCH SEARS  
\_\_\_\_\_

Title:

INTERIM GENERAL MANAGER  
\_\_\_\_\_

Date:

2/4/20  
\_\_\_\_\_

Approved as  
to Form:

  
\_\_\_\_\_

**Sacramento Municipal Utility District**

By:

  
\_\_\_\_\_

Name:

Arlen Orchard  
\_\_\_\_\_

Title:

Chief Executive Officer and General Manager  
\_\_\_\_\_

Date:

2/5/20  
\_\_\_\_\_

Approved as  
to Form:

  
\_\_\_\_\_



## **AMENDMENT 15 TO EXHIBIT A: Scope of Services**

### **A.4 Task Order 4 – Operational Staff Services**

SMUD and VCEA agree to the following services, terms, and conditions described in this Amendment 15 to Exhibit A, Task Order No. 4 (Amendment 15), the provisions of which are subject to the terms and conditions of the Master Professional Services Agreement (Agreement) between the Parties. If any specific provisions of this Amendment 15 conflict with any general provisions in the Agreement or Task Order No. 4, the provisions of this Amendment 15, shall take precedence. Capitalized terms used in this Amendment which are not defined in this Amendment will have the respective meanings ascribed to them in the Agreement or a previous Amendment thereof.

1. In accordance with the terms of Task Order No. 4, this Amendment 15 is to memorialize the cancelation of the On-Call Proxy Power Director as documented in Amendment 5 to Exhibit A, Scope of Services. This termination is effective as of December 20, 2019.
2. Pursuant to Section 1.2 Professional Services of Task Order No. 4, the Parties agree to the following additional scope of services:

SMUD will provide as-needed support to VCEA, as requested by VCEA, to transition the duties of the Power Proxy Director to a VCEA employee. Support, may include but not be limited to, the following:

- Energy Procurement – Work with the General Manager to support research and due diligence for potential power supply opportunities, negotiation of power purchase agreements, development and execution of VCEA’s renewable, local and zero-carbon procurement efforts, issue identification, and contract dispute resolution.
- Program Development – Work with the VCEA staff team on complementary energy program development and implementation that may include some or all of the following: net energy metering, feed in tariff, energy efficiency and demand management, battery storage, electric vehicle and other transportation incentives, distributed energy resource development, and other programs that advance VCEA’s mission, provide community and consumer benefits, and support carbon reduction goals.
- Finance - Assist in analysis relating to energy supply and local energy development, and support budget analysis for rate design and rate setting.
- Regulatory - Work with the VCEA General Manager and Regulatory Counsel to

provide quantitative analysis focused on VCEA's energy supply portfolio, VCEA's load forecast, and broader California energy market conditions, with a particular focus on all quantitative inputs into the Power Charge Indifference Adjustment, in addition to coordinating required regulatory reporting, and represents VCE as needed before regulatory and legislative bodies, and key industry groups.

This work will be provided at the current hourly rates for Professional Services and will be billed monthly in arrears, due Net 30.

**SIGNATURES**

The Parties have executed this Amendment 15, and it is effective as of the date of last signature below.

**Valley Clean Energy Alliance**

**By:** \_\_\_\_\_

**Name:** \_\_\_\_\_

**Title:** \_\_\_\_\_

**Date:** \_\_\_\_\_

**Approved as to Form:** \_\_\_\_\_

**Sacramento Municipal Utility District**

**By:** \_\_\_\_\_

**Name:** \_\_\_\_\_

**Title:** \_\_\_\_\_

**Date:** \_\_\_\_\_

**Approved as**

**to Form:** \_\_\_\_\_

## VALLEY CLEAN ENERGY ALLIANCE

### Staff Report – Item 15

---

**TO:** VCE Board of Directors

**FROM:** George Vaughn, Director of Finance & Internal Operations

**SUBJECT:** Update to Employer Share of Medical Premiums; and update to Valley Clean Energy Employee Handbook

**DATE:** February 13, 2020

---

#### Recommendation

1. Adopt a resolution approving the updated employer share of medical premiums, benefits eligibility date and update made to the Valley Clean Energy (VCE) Employee Handbook (Handbook).

#### Background

VCE currently contributes up to \$1,000 per month per employee towards VCEA's medical, dental and vision insurance for a full-time employee and dependents coverage. VCEA will contribute a prorated amount for part-time employees based on the average hours worked (for example, if the part-time employee is regularly scheduled to work 30 hours per week, VCEA's contribution toward the cost of VCEA's medical, dental and vision insurance coverage for the part time employee and his/her eligible dependents would be prorated to 75% of the full-time equivalent, i.e., \$750). The employee is responsible for any premiums due for VCEA coverage(s) that are in excess of the VCEA contribution amount.

The current VCE policy also states that employees become eligible for medical, dental and vision insurance on the first of the month after the employee has completed 30 days of service with VCE. (E.g., if an employee starts work for VCE on January 15, 2020, the employee would become benefits eligible on March 1, 2020).

However, to remain competitive in the recruiting and retention of high-caliber energy industry employees VCE has determined that a higher contribution amount and more rapid eligibility will make us more competitive in the CCA recruiting process and provide higher retention and satisfaction – at a minimal cost to VCE.

Staff recommends that the \$1,000 per month be increased to \$1,650 per month. This is the approximate amount to cover an employee plus two dependents on a standard Kaiser Gold plan for 2020, including dental and vision.

Staff also recommends that employees become eligible for medical, dental and vision insurance on the first of the month after the employee has started employment with VCE. (E.g., if an employee starts work for VCE on January 15, 2020, the employee would become benefits eligible on February 1, 2020).

These changes bring us closer in line with other comparative entities, including other CCA's surveyed and SMUD. Out of four companies surveyed, the approximate range of employer covered contributions and similar benefits is in the \$1,200 to \$3,000 range. Three out of the four surveyed entities exceed the \$1,650 staff is proposing.

Staff requests that the Board approve this change, along with the following redline changes to the employee handbook benefits section to implement the medical benefits increase:

**Medical, Dental and Vision Insurance:** We provide access to medical, dental & vision insurance plans for eligible employees and their dependents. You may be required to provide adequate proof of the dependent relationship in order to add the dependents to VCEA's insurance policies. Typically proof of the relationship may be established through a copy of a birth certificate, adoption documents, marriage license, or certificate of registered domestic partnership. We cannot guarantee your domestic partner relationship will be kept confidential.

Full-time employees and part-time employees who are regularly scheduled to work a minimum of 30 hours per week are eligible for VCEA's medical, dental, and vision insurance coverage. Each employee becomes eligible on the first of the month after the employee has ~~completed 30 days of continuous~~started employment with VCEA. VCEA will contribute up to ~~\$1,000~~\$1,650 per month per employee towards VCEA's medical, dental and vision insurance for a full-time employee and dependents coverage. VCEA will contribute a prorated amount for part-time employees based on the average hours worked (for example, if the part-time employee is regularly scheduled to work 30 hours per week, VCEA's contribution toward the cost of VCEA's medical, dental and vision insurance coverage for the part time employee and his/her eligible dependents would be prorated to 75% of the full-time equivalent, i.e., ~~\$750~~\$1,237.50). The employee is responsible for any premiums due for VCEA coverage(s) that are in excess of the VCEA contribution amount. Deductions from the employee's paycheck will be made to cover this cost. Information describing medical, dental and vision insurance benefits will be given to you when you become eligible to participate in the program. Eligible employees who elect not to receive medical insurance coverage from VCEA must provide proof of adequate medical coverage from an alternate source within 30 days of becoming eligible through VCEA for the benefit. Such election will be effective as of the employee's eligibility date and will remain in effect until the start of the next open enrollment period. Employees who have declined VCEA medical insurance coverage and want to continue to decline coverage must provide proof of adequate medical coverage once per year, no later than 30 days prior to VCEA's open enrollment period. Full time employees who decline to accept VCEA medical, dental, and vision insurance benefits shall receive a payment of \$500 per month in lieu of coverage; part -time employees who are eligible for VCEA medical, dental and vision insurance and decline to accept VCEA medical, dental, and vision insurance shall receive a prorated payout based on the

employee's regularly scheduled hours (i.e., an employee who is regularly scheduled to work 30 hours per week will receive 75% of the full-time equivalent, or \$375.)

**Attachment**

1. Resolution

**VALLEY CLEAN ENERGY ALLIANCE**

**RESOLUTION NO. 2020-\_\_\_**

**RESOLUTION OF THE BOARD OF DIRECTORS OF THE VALLEY CLEAN ENERGY ALLIANCE  
APPROVING THE UPDATES TO THE EMPLOYEE HANDBOOK**

**WHEREAS**, the Valley Clean Energy Alliance (“VCE”) is a joint powers agency established under the Joint Exercise of Powers Act of the State of California (Government Code Section 6500 et seq.) (“Act”), and pursuant to a Joint Exercise of Powers Agreement Relating to and Creating the Valley Clean Energy Alliance between the County of Yolo (“County”), the City of Davis (“Davis”), the City of Woodland and the City of Winters (“Cities”) (the “JPA Agreement”), to collectively study, promote, develop, conduct, operate, and manage energy programs;

**WHEREAS**, on January 18, 2018, the Valley Clean Energy Employee Handbook was adopted; and,

**WHEREAS**, on January 23, 2019, the Board approved updates to the employment regulations and edits to payroll operational procedures to the Employee Handbook; and,

**WHEREAS**, on July 11, 2019, the Board approved updates to the Employee Handbook incorporating new laws and personnel requirements; and,

**WHEREAS**, the current Employee Handbook needs to be updated to reflect benefits eligibility date; and,

**WHEREAS**, in order to be competitive in the recruiting and retention of energy industry employees, a higher contribution amount per month per employee towards VCE’s medical, dental and vision insurance for a full-time employee and dependents coverage needs to be incorporated within the Employee Handbook.

**NOW, THEREFORE**, the Board of Directors of the Valley Clean Energy Alliance resolves as follows:

1. Adopt changes to the **Employee Handbook (July 2019), Insurance Benefits** (page 34), **Medical, Dental and Vision Insurance** (2<sup>nd</sup> paragraph) as follows:

**Medical, Dental and Vision Insurance:** Full-time employees and part-time employees who are regularly scheduled to work a minimum of 30 hours per week are eligible for VCEA’s medical, dental, and vision insurance coverage. Each employee becomes eligible on the first of the month after the employee has ~~completed 30 days of continuous~~ started employment with VCEA. VCEA will contribute up to ~~\$1,000~~ \$1,650 per month per employee towards VCEA’s medical, dental and vision insurance for a full-time employee and dependents coverage. VCEA will contribute a prorated amount for part-time employees based on the average hours worked (for example, if the part-time employee is regularly scheduled to work 30 hours per week, VCEA’s contribution toward the cost of VCEA’s

medical, dental and vision insurance coverage for the part time employee and his/her eligible dependents would be prorated to 75% of the full-time equivalent, i.e., **\$750 \$1,237.50**. The employee is responsible for any premiums due for VCEA coverage(s) that are in excess of the VCEA contribution amount. Deductions from the employee's paycheck will be made to cover this cost. Information describing medical, dental and vision insurance benefits will be given to you when you become eligible to participate in the program. Eligible employees who elect not to receive medical insurance coverage from VCEA must provide proof of adequate medical coverage from an alternate source within 30 days of becoming eligible through VCEA for the benefit. Such election will be effective as of the employee's eligibility date and will remain in effect until the start of the next open enrollment period. Employees who have declined VCEA medical insurance coverage and want to continue to decline coverage must provide proof of adequate medical coverage once per year, no later than 30 days prior to VCEA's open enrollment period. Full time employees who decline to accept VCEA medical, dental, and vision insurance benefits shall receive a payment of \$500 per month in lieu of coverage; part -time employees who are eligible for VCEA medical, dental and vision insurance and decline to accept VCEA medical, dental, and vision insurance shall receive a prorated payout based on the employee's regularly scheduled hours (i.e., an employee who is regularly scheduled to work 30 hours per week will receive 75% of the full-time equivalent, or \$375.)

**PASSED, APPROVED, AND ADOPTED**, at a regular meeting of the Valley Clean Energy Alliance, held on the \_\_\_ day of \_\_\_\_\_ 2020, by the following vote:

AYES:

NOES:

ABSENT:

ABSTAIN:

---

Don Saylor, VCE Chair

---

Alisa M. Lembke, VCE Board Secretary



## VALLEY CLEAN ENERGY ALLIANCE

### Staff Report – Item 16

---

**TO:** VCE Board of Directors

**FROM:** Mitch Sears, Interim General Manager  
Jim Parks, Director of Customer Care and Marketing

**SUBJECT:** Net Energy Metering (NEM) Policy Change

**DATE:** February 13, 2020

---

#### REQUESTED ACTION

Approve a revision to the VCE NEM policy as detailed in this report.

#### BACKGROUND

At the October 2019 VCE board meeting, the board approved changes to the NEM policy that allows existing VCE customers (customers that installed solar systems after our start-up in June 2018) to request annual billing. Prior to this change, the only option for existing VCE NEM customers was monthly billing. The policy became effective January 1, 2020. The policy states “The request must coincide with their existing PG&E true-up period.” The purpose for this statement was to protect available solar credits and to keep customers’ annual billing date consistent between VCE and PG&E. The SMUD billing system was designed to automatically true-up a customer account when the billing cycle changes, so a request to move from monthly billing to annual billing triggers a true-up.

#### UPDATE

Since that time, customers have approached VCE staff to request a switch to annual billing that does not coincide with their annual PG&E billing cycle. Customers that request annual billing off-cycle from their annual PG&E true-up would get two true-up bills in the first year—one from PG&E for the delivery charges, and one from VCE for the generation charges. As an example, if a customer’s PG&E true-up month is November and they request a switch to VCE’s annual billing cycle in February, the customer would get a true-up upon their switch in February, then would get their annual true-up, for both PG&E delivery charges and VCE generation charges in November. Going forward, the customer would true-up both sides of the bill annually in November. Historically, NEM customers are used to one annual bill and this change would keep that intact except for the first year.

## REVISION TO APPROVED NEM POLICY

Staff recommends a policy modification based on customer feedback. NEM policy item #4 is the only section of the policy that would be amended. The revised policy is shown below in redline showing the addition and the strikeout.

4. NEM customers on monthly billing cycles may choose to adopt an annual billing cycle. It is recommended but not required that the request coincide with their existing PG&E true up period. ~~The request must coincide with their existing PG&E true up period.~~

This change will allow customers to switch to an annual billing cycle at any time during the year. When customers make this request, VCE and call center staff will inform them that 1) their off-cycle requests may result in two true-up bills in the first year and 2) their accounts will be trued-up when they switch. It is expected that a small number of customers will use this option, but the proposed change will provide VCE staff with the flexibility to accommodate these requests.

## VALLEY CLEAN ENERGY ALLIANCE

### Staff Report – Item 17

---

**TO:** VCE Board of Directors

**FROM:** Mitch Sears, Interim General Manager  
Jim Parks, Director of Customer Care and Marketing

**SUBJECT:** Approval of VCE Sponsorship Guidelines

**DATE:** February 13, 2020

---

#### RECOMMENDATION

1. Approve a resolution adopting the attached “Valley Clean Energy Sponsorship Program Guidelines” and authorizing the Interim General Manager to make minor amendments to the guidelines as-needed provided they are consistent with the intent and purpose of the guidelines.

#### BACKGROUND and ANALYSIS

VCE staff occasionally get requests to sponsor organizations, projects, or events, but have not up to this point, had a policy in place to guide sponsorship decisions. The attached document contains sponsorship guidelines and a sponsorship application to help guide staff when these requests come in. VCE currently has a sponsorship budget of approximately \$6,000 per year.

The purpose statement contained in the Guidelines is:

##### **Purpose of the program**

The goal of Valley Clean Energy’s sponsorship program is to increase awareness of VCE and the benefits it provides, build community alliances, support sustainability, increase electrification and energy efficiency, and support our community-based nonprofit partners. We hope to strengthen the connections between quality of life for the people in our region and the sustainability of the places they share.

Staff proposes that VCE-sponsored events will be exempt from the Guideline application process. These are events that VCE has sponsored in the past and/or staff believes will provide benefits to VCE by getting our message out to the community. Past events have included the Honey Festival, Carnitas Festival, Salmon Festival, Tomato Festival and the Yolo County Fair. The application process is intended to be used for events, programs and organizations where VCE or its customers will receive benefits, but VCE may not be involved beyond the sponsorship of an event.

Staff also requests permission to make minor adjustments to the Guidelines without returning to the Board for approval provided the minor amendments are consistent with the purpose of the guidelines. It is difficult to develop this type of policy that anticipates all potential requests.

Staff expects changes will be needed as the sponsorship program evolves. Staff believes that providing authorization for staff to make minor amendments to the policy would be an effective tool to adapt the policy provided the amendments are consistent with the intent and purpose of the policy. If there are significant changes proposed, staff would return to the Board for authorization.

#### **ATTACHMENTS**

1. Sponsorship Guidelines
2. Resolution

## **Valley Clean Energy Sponsorship Program Guidelines**

### **Purpose of the program**

The goal of Valley Clean Energy's sponsorship program is to increase awareness of VCE and the benefits it provides, build community alliances, support sustainability, increase electrification and energy efficiency, and support our community-based nonprofit partners. We hope to strengthen the connections between quality of life for the people in our region and the sustainability of the places they share.

### **Eligible applicants**

While VCE's sponsorship program is designed to harness the ingenuity and leadership of forward-thinking individuals within our communities, all applicants must be incorporated nonprofit or municipal organizations within VCE's service territory and/or providing services to VCE customers and/or aligns with VCE mission and goals. These include but are not necessarily limited to community-based non-profits, chambers of commerce, property-based improvement districts, neighborhood associations, school districts, local governments, and homeowners' associations.

Awarded sponsorship funds will be disbursed only to the identified applicant.

### **Eligible sponsorships**

To be eligible for funding, an applicant must be able to demonstrate that the proposed funds have a connection to VCE's mission and business objectives and/or encourages economic development that benefits VCE's customers. The sponsorship must promote positive change in the community/area it is intended to serve. This may include, but is not necessarily limited to initiatives promoting greenhouse gas reduction; improvements to increase energy efficiency or promote economic development; events promoting sustainability and efficiency, etc.

### **Organizations and projects that are not eligible to apply**

Some organizations/activities are ineligible for sponsorship funding. Examples include:

- Political or individual lobbying activities.
- Religious activities, in whole or in part, for the purpose of furthering religious doctrine. (Faith-based organizations may be considered if they provide services to all clients regardless of denomination.)
- Organizations that discriminate on the basis of race, creed, color, sex, or national origin.
- General operating support or travel expenses.
- School-affiliated field trips, fundraisers, sports teams, graduations or performing arts events.
- Organizations whose services are not provided in VCE's service territory.
- Donations of VCE electric service for which a fee is normally charged.

### **VCE's mission and values**

At Valley Clean Energy, our mission is to deliver clean electricity, product choice, investment in the community, and greenhouse gas emission reductions—all with local control at competitive prices.

VCE is proud to give back to our community by supporting efforts that improve quality of life in our region. Through the financial support of programs, organizations, and events, we seek partnerships with eligible applicants that support projects, initiatives and events that make a difference and align with and promote the following:

1. Sustainability/greenhouse gas reductions
  - a. Renewable energy
  - b. Energy efficiency
  - c. Electrification measures
  - d. Energy security
  - e. Energy storage
  - f. Demand response
  - g. Environmental stewardship
2. Education
  - a. Focusing on areas related to VCE’s mission such as environmental sustainability
  - b. Innovative educational programs
3. Community
  - a. Healthy and Sustainable Communities
4. Awareness of VCE
5. Reinvestment in the community

### **Funding priorities**

From among all eligible sponsorships, VCE will prioritize funding for those that include one or more of the following elements:

- Promotion of energy efficiency, energy conservation and greenhouse gas reduction.
- New investment in emerging renewable energy resources and technologies.
- Education related to energy efficiency, renewable energy or STEM-related fields.
- Services provided to low-income electricity customers.
- Community and workforce development, particularly for diverse and underserved communities.
- Energy-related programs focused on disadvantaged communities.

### **Sponsorship amounts**

Sponsorships range depending on need, alignment with VCE mission and goals, cost share, and availability of funds. Sponsorships are typically in the range of \$100 to \$1,000.

### **Matching requirements**

Matching funds may be required depending on the sponsorship. For general event sponsorships, recipients may be required to identify match funds. For project sponsorships, a

minimum 50% match is required. Projects with higher match funding will receive higher priority for sponsorship funds. Matching funds may be provided as cash, in-kind, or a combination of cash and in-kind.

In-kind contributions are defined as materials or labor that an organization commits to a project in-lieu of cash.

For materials, we request that applicants use the retail value of the goods or materials provided.

### **Funding disbursements**

Funding disbursements will be lump-sum.

### **Fiscal and performance reporting**

Project sponsorship recipients may be required to submit performance reports that document progress toward accomplishing project milestones and achieving identified performance metrics. Reporting requirements will be determined individually for each funded project and based upon that project's unique characteristics.

### **How to apply**

To apply for a sponsorship, please fill out the attached application.

**Please note:** Application submission is not a guarantee of a funding award.

## Request for Sponsorship from Valley Clean Energy

### Application

Organization Name: \_\_\_\_\_

Organization Contact: \_\_\_\_\_

Title: \_\_\_\_\_

This request is for (circle one):

- a. Non-profit
- b. School/Educational Foundation
- c. Chambers/Business Group
- d. Local government
- e. Other

I/We are customers of VCE:    Yes \_\_\_\_\_    No \_\_\_\_\_

Address: \_\_\_\_\_

City: \_\_\_\_\_ State: \_\_\_\_\_

Zip Code: \_\_\_\_\_ Phone: \_\_\_\_\_

Email: \_\_\_\_\_

Organization Website: \_\_\_\_\_

### Details

- a. Event/effort Name: \_\_\_\_\_
- b. Date of Event: \_\_\_\_\_
- c. Location: \_\_\_\_\_
- d. VCE's response date: \_\_\_\_\_



e. Other confirmed event sponsors (if applicable): \_\_\_\_\_

\_\_\_\_\_

f. Please provide a brief description of the event/opportunity: \_\_\_\_\_

\_\_\_\_\_

\_\_\_\_\_

\_\_\_\_\_

g. Projected Attendance: \_\_\_\_\_

h. Target Audience: \_\_\_\_\_

Please tell us which of VCE's community outreach program core focus areas this effort/event supports (Circle all that apply):

a. GHG Reductions and Climate Solutions

b. Local education/schools (with an emphasis on STEM programs)

c. Basic Needs (food, housing, family support serves, etc.)

d. Yolo County Business Communities

e. Yolo County Key Industries/Key Economic Drivers

f. Creating Visibility Awareness for VCE's service territory

g. Other (please describe) \_\_\_\_\_

\_\_\_\_\_

Please provide additional information you may have about the event/effort (optional)

#### Sponsorship Elements

a. Please explain how VCE will benefit from sponsoring the event/effort (i.e.

brand/logo recognition, signage, public relations, print/program ad, onsite

opportunities, etc.): \_\_\_\_\_

---

---

---

b. Requested sponsorship amount: \_\_\_\_\_

Please submit your form to Valley Clean Energy at least 30 days in advance of the event.

Thank you for considering VCE to sponsor your effort/event.

**VALLEY CLEAN ENERGY ALLIANCE**

**RESOLUTION NO. 2020-\_\_\_**

**RESOLUTION OF THE BOARD OF DIRECTORS OF THE VALLEY CLEAN ENERGY ALLIANCE  
ADOPTING THE VALLEY CLEAN ENERGY SPONSORSHIP PROGRAM GUIDELINES**

**WHEREAS**, the Valley Clean Energy Alliance (“VCE”) is a joint powers agency established under the Joint Exercise of Powers Act of the State of California (Government Code Section 6500 et seq.) (“Act”), and pursuant to a Joint Exercise of Powers Agreement Relating to and Creating the Valley Clean Energy Alliance between the County of Yolo (“County”), the City of Davis (“Davis”), the City of Woodland and the City of Winters (“Cities”) (the “JPA Agreement”), to collectively study, promote, develop, conduct, operate, and manage energy programs;

**WHEREAS**, VCE is engaged with communities located within our agency jurisdictions; and,

**WHEREAS**, the purpose of a Sponsorship Program is to increase awareness of VCE and the benefits it provides, build community alliances, support sustainability, increase electrification and energy efficiency, and support our community-based nonprofit patterns; and,

**WHEREAS**, in anticipation of VCE receiving requests to sponsor organizations, projects, or events, there is a need to establish guidelines; and,

**WHEREAS**, Sponsorship Program Guidelines will exclude VCE sponsored events; and,

**WHEREAS**, Sponsorship Program Guidelines include an application process intended to be used for events, programs and organizations where VCE or its customers will receive benefits.

**NOW, THEREFORE**, the Board of Directors of the Valley Clean Energy Alliance resolves as follows:

1. Adopt the attached “Valley Clean Energy Sponsorship Program Guidelines” and authorize the Interim General Manager to make minor amendments to the guidelines as-needed provided they are consistent with the intent and purpose of the guidelines.

**PASSED, APPROVED, AND ADOPTED**, at a regular meeting of the Valley Clean Energy Alliance, held on the \_\_\_ day of \_\_\_\_\_ 2020, by the following vote:

AYES:

NOES:

ABSENT:

ABSTAIN:

---

Don Saylor, VCE Chair

---

Alisa M. Lembke, VCE Board Secretary

Attachment A: Valley Clean Energy Sponsorship Program Guidelines

## **Attachment A**

### **Sponsorship Guidelines**

**VALLEY CLEAN ENERGY ALLIANCE  
Board of Directors Meeting**

**Staff Report - Item 18**

---

**TO:** VCEA Board

**FROM:** Alisa Lembke, Board Clerk/Administrative Analyst

**SUBJECT:** Recognition of Community Advisory Committee Members Gerry Braun and Christine Shewmaker

**DATE:** February 13, 2020

---

**Recommendation**

Staff recommends recognizing via Resolution the service of Community Advisory Committee original Chair, Gerry Braun, and original Vice Chair, Christine Shewmaker.

Attachments: Resolution recognizing Gerry Braun  
Resolution recognizing Christine Shewmaker



# VALLEY CLEAN ENERGY ALLIANCE

## A RESOLUTION HONORING GERRY BRAUN FOR HIS SERVICE AS THE ORIGINAL CHAIR OF THE VCE COMMUNITY ADVISORY COMMITTEE

**WHEREAS**, Gerry Bruan, resident of the City of Davis, served on the Davis Community Choice Energy Advisory Committee and participated with City staff in the investigation and efforts to determine the feasibility of creating a local Community Choice Aggregation program; and,

**WHEREAS**, in December 2016, Valley Clean Energy Alliance Joint Powers Agency was formed, and the Board of Directors created the Community Advisory Committee at which time, Gerry Braun was appointed as a member; and

**WHEREAS**, Gerry Braun has served as the original Chair from the inception of the VCE Community Advisory Committee; and

**WHEREAS**, his leadership on the Community Advisory Committee was instrumental in helping VCE launch successfully, navigate the challenges of VCE's early operations, and form an effective Community Advisory Committee; and

**WHEREAS**, his career in the energy sector and deep experience in energy planning and regulatory matters contributes significantly to the Board's confidence in the community advisory process; and

**WHEREAS**, his commitment to community based power and environmental sustainability contributed significantly in forming and launching Valley Clean Energy as a Community Choice Aggregation program; and

**WHEREAS**, his knowledge and understanding of the needs of the community of customers enriches the Valley Clean Energy Board of Directors' and Community Advisory Committee's perspective and efficacy; and

**WHEREAS**, his commitment to greener, more renewable sources of locally controlled energy for local communities enhances the value that Valley Clean Energy Alliance offers its customers; and

**NOW THEREFORE**, on February 13, 2020, we, as the Board Chair and Interim General Manager, on behalf of the VCE Board of Directors, do hereby extend heartfelt appreciation and gratitude to Gerry Braun for his outstanding service to VCE and recognition of his leadership of the Community Advisory Committee of Valley Clean Energy as its first Chair.

---

Don Saylor  
Board Chair

---

Mitch Sears  
Interim General Manager



# VALLEY CLEAN ENERGY ALLIANCE

## A RESOLUTION HONORING CHRISTINE SHEWMAKER FOR HER SERVICE AS THE ORIGINAL VICE-CHAIR OF THE VCE COMMUNITY ADVISORY COMMITTEE

**WHEREAS**, the City of Woodland became a member of Valley Clean Energy Alliance Joint Powers Agency on June 13, 2017, at which time, Christine Shewmaker was appointed as a member on the Advisory Committee; and,

**WHEREAS**, Christine Shewmaker has served as the original Vice Chair from the inception of the VCE Community Advisory Committee; and,

**WHEREAS**, her leadership on the Community Advisory Committee was instrumental in helping VCE launch successfully, navigate the challenges of VCE's early operations, and form an effective Community Advisory Committee; and

**WHEREAS**, her career in the plant biology / plant molecular biology field and experience as a community activist on climate change contributes significantly to the Board's confidence in the community advisory process; and,

**WHEREAS**, her knowledge and understanding of the needs of the community of customers enriches the Valley Clean Energy Board of Directors' and Community Advisory Committee's perspective and efficacy; and

**WHEREAS**, her commitment to greener, more renewable sources of locally controlled energy for local communities enhances the value that Valley Clean Energy Alliance offers its customers.

**NOW THEREFORE**, on February 13, 2020, we, as the Board Chair and Interim General Manager, on behalf of the VCE Board of Directors, do hereby extend heartfelt appreciation and gratitude to Christine Shewmaker for her outstanding service to VCE and recognition of her leadership of the Community Advisory Committee of Valley Clean Energy as its first Vice-Chair.

---

Don Saylor  
Board Chair

---

Mitch Sears  
Interim General Manager



## VALLEY CLEAN ENERGY ALLIANCE

### Staff Report – Item 19

---

**TO:** Valley Clean Energy Alliance Board

**FROM:** Mitch Sears, Interim General Manager  
Michael Roberts, SMUD Principal, Energy Contracts

**SUBJECT:** Aquamarine Solar Power Purchase Agreement Approval

**DATE:** February 13, 2020

---

#### RECOMMENDATIONS

Staff recommends the Board adopt a resolution that:

1. Approves the Power Purchase Agreement (PPA) with Aquamarine Westside, LLC for the purchase by VCE of a 50 MW share of the 250 MW Aquamarine Solar Project under development by Westlands Solar Park, LLC.
2. Authorizes the Interim General Manager to execute the PPA substantially in the form attached and, in consultation with General Counsel, to make minor changes to the PPA so long as the term and price are not changed.

#### BACKGROUND

On August 13, 2018, SMUD, on behalf of VCE, issued a solicitation for Long Term Renewable power supply. Responses, which were received on September 17, 2018, included proposals from 13 developers for 32 projects, of which 23 were unique (some developers bid variants of the same project).

The Board received multiple updates on the solicitation process throughout 2018 and 2019. The solicitation and evaluation of proposals were managed by SMUD and overseen by VCE staff. The VCE team that developed and negotiated the Power Purchase Agreement (PPA), included highly experienced SMUD staff, the VCE Interim General Manager, and VCE's regulatory counsel Kevin Fox of Keyes and Fox.

#### Pass/Fail Consideration

After compiling and consolidating the technical details from each response, Projects were evaluated for Pass/Fail criteria. The Board will recall that the solicitation for proposals made clear that projects, at a minimum, had to satisfy certain criteria to even be considered. Those criteria with effective pass/fail scoring included:

**Table 1. Pass/Fail Criteria**

<b>Criteria</b>	<b>Pass/Fail Threshold</b>
Siting	Projects cannot be proposed for land with a prime agricultural designation. Projects cannot be proposed for areas that are designated as Renewable Energy Transmission Initiative (“RETI”) Category 1 or 2. Category 1 lands are those identified where development is prohibited by law or policy. Category 2 lands are those where cultural or environmental conflicts would be highly likely and/or controversial.
Development Status	Projects must at least have filed a permit application with the relevant land use authority and received an acknowledgment of the filing from such authority. Projects must provide evidence of site control.
Out-Of-State Resources	Projects must be located within California.
Interconnection Status	Projects must already be in an interconnection queue and have requested full capacity deliverability for the project interconnection.

**Preliminary Screening**

The next step was to perform a preliminary screening that was used to reduce the project list to a limited number of projects that would then receive an economic evaluation and consideration for a short list. In the preliminary screening, projects were ranked. Ranking criteria included:

- Permit progress
- Status of Cultural/Environmental surveys
- Whether or not sensitive cultural or habitat resources were identified
- CEQA status
- Whether wildlife permits were needed and obtained
- Location of project (northern California preferred)
- Whether the project was local, regional or other
- Whether project could be online and delivering energy by April 1, 2021

Only the 9 highest ranked projects were selected to move on to the short list evaluation stage.

**Short List Evaluation**

Economic evaluations were performed on the 9 projects, where the levelized contract prices were compared to expected value from sales of the power component back to the CAISO and resource adequacy capacity value. The result of the economic evaluations was to determine an implicit renewable premium for each project, compared to VCE’s current renewable costs. The short-term Renewable Energy Certificate (REC) contracts in VCE’s 2020 power portfolio have an average renewable premium of \$13.79/MWh.

Key factors in determining which projects to short list were:

- Total energy delivered from all selected projects will meet the legal requirement for significant energy under long term contract in the upcoming Compliance Period.
- Price (value)
- Selection of projects will supply at least the VCE minimum 42% renewable content.

### **Short List Selection**

Two projects were short listed, a 72 MW solar project, and the 40 MW Aquamarine solar project. Neither of the projects are considered either Local or Regional projects by VCE's definition. They both were selected for the following key reasons:

- The two projects provided a renewable volume totaling at least 42% of VCE overall energy portfolio
- Both projects had favorable pricing
- No other combination of projects provided enough energy to satisfy the RPS minimum long-term contracting requirements which begin in 2021.

### **Remaining Selection Process**

Following the short-list process, staff executed letters of intent, collected short list deposits and began PPA negotiations. This staff report discusses the first PPA negotiated with the Aquamarine project in the Westlands solar park. During the course of PPA negotiations, the original 40 MW project size was increased to 50 MW.

### **WESTLANDS SOLAR PARK/AQUAMARINE PROJECT**

Westlands solar park is a power generating complex located on 20,000 acres of "brownfield" land within the Westlands Water District in Kings County, CA. The project will be built on land that has already been retired, or is planned to be retired, from full agricultural use.

Westlands plans to phase in construction of potentially 2,700 MW of solar power including storage and transmission facilities. Aquamarine is a 250 MW solar generating facility and is included in the first phase of construction for Westlands. VCEA has negotiated the purchase of 50 MW of power from this project.

During discussions staff discovered a mutual interest between VCEA and Westlands regarding the contracting of additional capacity from subsequent construction phases of the Westlands Solar Park. VCEA executed a Letter of Intent for the initial 50 MW PPA from the Aquamarine Project, 50 MW from the next 250 MW project (to be named later), and a 50MW option for additional solar power from additional phases.

For clarity, each tranche of power purchased from the Westlands solar park will be governed by its own PPA. The first PPA is a 50 MW portion of the first 250 MW phase of construction; the second 50 MW PPA would derive from the second phase of construction, and the option for a third 50 MW PPA would come from perhaps another phase of construction.

### **KEY PPA TERMS AND CONDITIONS**

#### **Price and Impact to VCE Budget**

[\$[Price Redacted]/MWh with 0% escalation. Specifically, the price is held flat, or levelized, across the 15 year term. This price can potentially be reduced by \$2.49/MWh to \$[Price Redacted]/MWh if VCE can establish and maintain certain credit support requirements. Forms of credit support generally are cash, Letter of Credit, or an investment-grade credit rating on VCE's long-term indebtedness.

Staff expects REC costs from Aquamarine, as a portion of the overall PPA cost, to be favorable to VCE’s budget. For 2020, VCE paid an average of \$13.79/MWh for RECs alone. This PPA is structured as fixed price, versus VCE’s short term renewable contracts, which are based on index power price plus a fixed REC premium. In addition to contributing savings on the average cost of RECs in the near term, a fixed price contract reduces the volatility in VCE’s future power costs.

This project is expected to yield 134,684 MWh per year. Based on historical energy prices at the project’s point of delivery, staff have estimated an implicit renewable premium of \$8.13/MWh for the project in 2021, compared to VCE’s average short-term renewable cost in 2020 of \$13.79/MWh. As energy prices at the project’s point of delivery vary from historical, this will affect the implicit renewable premium accordingly. This reduces VCE’s annual renewable costs by approximately \$762,000. The Aquamarine project also provides Resource Adequacy (RA) capacity which has a value but is not included in the \$762,000 cost savings above. An estimate of the RA value is not provided as the CPUC is currently assessing the RA value that solar photovoltaic (PV) projects provide. In any case, any RA value would be in addition to the cost savings noted above.

**Term**

Pricing for the Aquamarine Project was offered for both 15 year and 20 year terms. Staff selected the 15 year term because of the more favorable pricing for the shorter term.

**Expected Annual Energy Product/Portfolio Share of Renewable Provided**

The expected annual energy production is 134,684 MWhs, which would supply 18.2% of VCEs annual energy retail needs. Table 2 below shows the anticipated Aquamarine project annual production.

**Table 2. Incremental Portfolio Contribution from Long Term Renewable PPAs**

	Project COD	PPA Capacity	2021	2022	2023
<b>Short Listed Projects</b>					
<i>Project 1</i>	11/1/2021	0 MWs	0	0	0
<b>Aquamarine</b>	8/1/2021	50 MWs	47,438	134,684	134,011
<i>Project 2 Phase 2</i>	12/1/2021	0 MWs	0	0	0
<i>Project 2 Option</i>	7/1/2022	0 MWs	0	0	0
<b>Total Supply</b>		50 MWs	47,438	134,684	134,011
<b>VCEA Retail Load</b>			740,117	739,992	741,517
<b>RPS Minimum Requirements</b>			35.8%	38.5%	41.3%
<b>Minimum LT Contracting Requirement</b>			171,985	185,183	198,819
<b>Incremental Contribution to Renewable Content</b>			6.4%	18.2%	18.1%

**Full Capacity Deliverability Status**

The project has requested Full Capacity Deliverability Status (FCDS) from the CAISO, which means they have an interconnection agreement that ensures that once transmission upgrades (paid for by Westlands) are completed, the full output of the Project can be accommodated by the transmission system. Having FCDS also ensures that VCE can benefit from the Resource Adequacy Capacity allocated to the Project.

**CONCLUSION**

Based on results from the solicitation process and PPA negotiation, VCE and SMUD staff believe the price and terms of the PPA support VCE's policy objectives, help meet regulatory requirements, and are competitive in the current market for utility scale solar PV in California.

**REQUESTED ACTION**

Adopt the resolution detailed above.

**ATTACHEMENTS**

1. Resolution
2. Power Purchase Agreement (Redacted)

**Attachment A**

**Aquamarine Power Purchase Agreement  
(Redacted)**

**VALLEY CLEAN ENERGY ALLIANCE**

**RESOLUTION NO. 2020-\_\_\_**

**RESOLUTION OF THE BOARD OF DIRECTORS OF THE VALLEY CLEAN ENERGY ALLIANCE (VCE) APPROVING ENTERING INTO A POWER PURCHASE AGREEMENT WITH AQUAMARINE WESTSIDE, LLC AND AUTHORIZING INTERIM GENERAL MANAGER IN CONSULTATION WITH LEGAL COUNSEL TO FINALIZE AND EXECUTE THE POWER PURCHASE AGREEMENT**

**WHEREAS**, the Valley Clean Energy Alliance (“VCE”) is a joint powers agency established under the Joint Exercise of Powers Act of the State of California (Government Code Section 6500 et seq.) (“Act”), and pursuant to a Joint Exercise of Powers Agreement Relating to and Creating the Valley Clean Energy Alliance between the County of Yolo (“County”), the City of Davis (“Davis”), the City of Woodland and the City of Winters (“Cities”) (the “JPA Agreement”), to collectively study, promote, develop, conduct, operate, and manage energy programs;

**WHEREAS**, on August 13, 2018, Sacramento Municipal Unified District (“SMUD”), on behalf of VCE, issued a solicitation for Long Term Renewable power supply;

**WHEREAS**, after compiling and consolidating the technical details from each response received and evaluating for consideration, VCE Staff executed letters of intent, collected short list deposits, and began negotiating power purchase agreements (“PPA”) for two (2) projects;

**WHEREAS**, Westlands Solar Park (“Westlands”) is a power generating complex located on 20,000 acres of “brownfield” land within the Westlands Water District in Kings County, California with Westlands planning to phase in construction of potentially 2,700 megawatts (“MW”) of solar power including storage and transmission facilities;

**WHEREAS**, Aquamarine is a 250 MW solar generating facility and is included in the first phase of construction for Westlands; and,

**WHEREAS**, a PPA was negotiated with Aquamarine Westside, LLC for VCE to procure power from a fifty (50) MW share of the two hundred fifty (250) MW Aquamarine Solar Project being developed by Westlands.

**NOW, THEREFORE**, the Board of Directors of the Valley Clean Energy Alliance resolves as follows:

1. The Power Purchase Agreement (PPA) with Aquamarine Westside, LLC for the procurement of power by Valley Clean Energy Alliance of a fifty (50) megawatt (MW) share of the two hundred fifty (250) MW Aquamarine Solar Project under development by Westlands Solar Park, LLC is hereby approved.
2. The Interim General Manager is authorized to execute the PPA substantially in the form attached hereto on behalf of VCE, and in consultation with legal counsel is authorized to approve minor changes to the PPA so long as the term and price are not changed.

**PASSED, APPROVED, AND ADOPTED**, at a regular meeting of the Valley Clean Energy Alliance, held on the \_\_\_ day of \_\_\_\_\_ 2020, by the following vote:

AYES:

NOES:

ABSENT:

ABSTAIN:

---

Don Saylor, VCE Chair

---

Alisa M. Lembke, VCE Board Secretary

Attachment A: Exhibit A - Power Purchase Agreement with Aquamarine Westside, LLC



**Attachment A**

**Power Purchase Agreement with Aquamarine Westside, LLC**

**WESTLANDS SOLAR PARK**  
**POWER PURCHASE AGREEMENT**

**between**

**VALLEY CLEAN ENERGY ALLIANCE**

**(as “Buyer”)**

**and**

**AQUAMARINE WESTSIDE, LLC**

**(as “Seller”)**

**dated as of**

**JANUARY \_\_, 2020**

## TABLE OF CONTENTS

ARTICLE 1 DEFINITIONS.....	1
1.1 Definitions.....	1
ARTICLE 2 SALE AND PURCHASE OF ENERGY.....	16
2.1 Purchase and Sale of Energy.....	16
2.2 Contract Price.....	16
2.3 Dedication of Product to Buyer.....	17
2.4 Purchase and Sale of Green Attributes; Tax Credits.....	17
2.5 New Generation Facility.....	18
2.6 Commercial Operation.....	20
2.7 Title; Risk of Loss.....	21
2.8 Transmission; CAISO Payments and Charges; Curtailment.....	22
2.9 Scheduling; Forecasting; EIRP; Outage Notification.....	24
2.10 Capacity Rights.....	26
2.11 Sales for Resale.....	28
ARTICLE 3 TERM; TERMINATION; DEFAULTS.....	28
3.1 Term.....	28
3.2 Regulatory Approvals; Certifications; Qualifications.....	28
3.3 [Reserved].....	29
3.4 Defaults; Remedies; Termination Payment.....	29
3.5 Specific Performance; Injunctive Relief.....	32
3.6 Seller’s Financial Support Obligations.....	32
ARTICLE 4 BILLING AND PAYMENT; METERING AND MEASUREMENT.....	34
4.1 Billing; Payment.....	34
4.2 Metering Equipment.....	36
4.3 Maintenance; Records.....	38
4.4 Electronic Communications.....	39
ARTICLE 5 REPRESENTATIONS, WARRANTIES AND COVENANTS.....	39
5.1 Seller’s Representations and Warranties.....	39
5.2 Buyer’s Representations and Warranties.....	40
5.3 Seller’s Covenants.....	41
5.4 Buyer’s Financial Security.....	42
5.5 Guaranteed Energy Production.....	42
5.6 Access Rights.....	43
5.7 Facility Images.....	44
ARTICLE 6 INDEMNIFICATION AND INSURANCE.....	44
6.1 Indemnity.....	44
6.2 Insurance.....	44
ARTICLE 7 GOVERNMENT APPROVALS.....	46
7.1 Government Approvals – Seller’s Obligation.....	46
7.2 Government Approvals – Buyer’s Obligation.....	47
7.3 Changes In Law.....	47
ARTICLE 8 MISCELLANEOUS.....	48
8.1 Confidential Information.....	48
8.2 Successors and Assigns; Assignment.....	50

8.3	Lender Rights.....	51
8.4	Notices.....	51
8.5	Force Majeure.....	53
8.6	Amendments.....	54
8.7	Waivers.....	54
8.8	Waiver of Certain Damages.....	54
8.9	No Recourse to Members.....	54
8.10	Survival.....	55
8.11	Severability.....	55
8.12	Standard of Review.....	55
8.13	Governing Law.....	56
8.14	Consent to Jurisdiction.....	56
8.15	Waiver of Trial by Jury.....	56
8.16	Disputes.....	57
8.17	No Third-Party Beneficiaries.....	57
8.18	No Agency.....	57
8.19	Cooperation.....	57
8.20	Further Assurances.....	57
8.21	Captions; Construction.....	58
8.22	Entire Agreement.....	58
8.23	Counterparts.....	58
8.24	Forward Contract.....	58

Exhibit A	Contract Price
Exhibit B	Description of Facility
Exhibit B-1	Facility Site Plan
Exhibit C	Description of Delivery Point and One-Line/Metering Diagram
Exhibit D	Form of Corporate Guaranty
Exhibit E	Form of Lender Consent
Exhibit F	Minimum Annual Energy Production
Exhibit G	Form of Letter of Credit
Exhibit H	Expected Energy
Exhibit I	Milestone Schedule
Exhibit I-1	Form of Milestone Schedule Report
Exhibit J	Form of Commercial Operation Certificate
Exhibit K	Other Seller Facilities

## POWER PURCHASE AGREEMENT

This POWER PURCHASE AGREEMENT (this "*Agreement*") is entered this \_\_\_ day of January, 2020 (the "*Effective Date*"), by and between VALLEY CLEAN ENERGY ALLIANCE, a California Joint Powers Authority ("*Buyer*") and AQUAMARINE WESTSIDE, LLC, a Delaware limited liability company ("*Seller*"). Buyer and Seller are each individually referred to herein as a "*Party*" and collectively as the "*Parties*".

### WITNESSETH:

**WHEREAS**, Buyer is a Joint Powers Authority in accordance with the Joint Powers Act of the State of California (Government Code Section 6500 *et seq.*) that provides retail electricity service to customers within its service area;

**WHEREAS**, Seller and its affiliates are developing and will own and operate Westlands Solar Park, comprised of up to 2,700 MW-AC of solar photovoltaic systems, located on a Site in Kings County, California, including the 250 MW-AC Aquamarine project from which 50 MW-AC will be sold to Buyer by Seller; and

**WHEREAS**, Seller desires to sell and deliver, and Buyer desires to purchase and receive, all of the Energy, Green Attributes, and Capacity Rights (as each are defined below) from the Facility (as defined below), on the terms and conditions set forth herein;

**NOW, THEREFORE**, the Parties hereto, for good and sufficient consideration, the receipt of which is hereby acknowledged, intending to be legally bound, do hereby agree as follows:

### ARTICLE 1 DEFINITIONS

#### 1.1 *Definitions.*

Unless otherwise required by the context in which any term appears: (i) capitalized terms used in this Agreement have the meanings specified in this Article 1; (ii) the singular includes the plural and vice versa; (iii) references to "articles," "sections," "schedules," "appendices" or "exhibits" (if any) are to Articles, Sections, Schedules, Appendices or Exhibits hereof; (iv) all references to a particular entity or pricing index include a reference to such entity's or pricing index's successors and permitted assigns; (v) the words "herein," "hereof" and "hereunder" refer to this Agreement as a whole and not to any particular section or subsection hereof; (vi) all accounting terms not specifically defined herein shall be construed in accordance with generally accepted accounting principles in the United States of America, consistently applied; (vii) references to this Agreement include a reference to all appendices, schedules and exhibits hereto, as the same may be amended, modified, supplemented or replaced from time to time; (viii) the masculine includes the feminine and neuter and vice versa; (ix) the words "include" and "including" or similar words are not words of limitation and shall be deemed to be followed by the words "without limitation"; (x) all references to dollars are U.S. dollars, and all amounts due, and payments made, under this Agreement, shall be paid in U.S. dollars; and (xi) "or" is not

necessarily exclusive. The Parties collectively have prepared this Agreement, and none of the provisions hereof shall be construed against one Party on the ground that such Party is the author of this Agreement or any part hereof.

**“Affiliate”** means, with respect to any Person each Person that directly or indirectly, controls or is controlled by or is under common control with such designated Person.

**“After-Tax Basis”** means, with respect to any payment received or deemed to have been received by any Person, the amount of such payment (the **“Base Payment”**) supplemented by a further payment (the **“Additional Payment”**) to that Person so that the sum of the Base Payment plus the Additional Payment shall, after deduction of the amount of all federal, state and local income taxes required to be paid by such Person in respect to the receipt or accrual of the Base Payment and the Additional Payment (taking into account the net present value of any reduction in such income taxes resulting from tax benefits realized by the recipient as a result of the payment or the event giving rise to the payment), be equal to the amount of the Base Payment that was to have been received by such Person. Such calculations shall be made on the basis of the amounts of the highest generally applicable federal, state and local income tax applicable to a corporation for all relevant periods and shall take into account the deductibility of state and local income taxes for federal income tax purposes.

**“A.M. Best”** means A.M. Best Company, Inc.

**“Applicable Law”** means, with respect to any Person or the Facility, all laws, statutes, codes, acts, treaties, ordinances, orders, judgments, writs, decrees, injunctions, rules, regulations, governmental approvals, licenses and Permits, directives and requirements of all regulatory and other governmental authorities, in each case applicable to or binding upon such Person or the Facility (as the case may be).

**“Available Capacity”** means, for any given point in time, the maximum instantaneous generation Capacity of the Facility at the Delivery Point (expressed in MW).

**“Available Contract Capacity”** means, for each Settlement Interval in which there is a curtailment of the Facility during a Curtailment Period, Buyer’s Allocation of the Available Capacity that has not been curtailed and is available to generate Product. For example, if the Facility is curtailed during a Curtailment Period such that the Available Capacity is reduced to 125 MW, and Buyer’s Allocation is 20.0%, then Available Contract Capacity would be 25 MW.

**“Available Energy”** means Buyer’s Allocation of Energy that Seller would have generated and delivered to the Delivery Point from the Facility, but for (i) a Buyer Curtailment Order, or (ii) a suspension of Seller’s obligation to make Energy available due to a Buyer Event of Default pursuant to Section 3.4(a), in either case from equipment that would otherwise have been mechanically and electrically available for generation of Energy. The amount of Available Energy shall be determined by Seller using the best information available at the time including weather conditions or physical limitations and any other factors relevant to the determination. Seller shall be responsible for collecting

and archiving Site insulation in order to determine the Available Energy from the Facility.

**“Back-up Meter”** means a CAISO approved revenue quality meter installed by Seller pursuant to Section 4.2(d) that is capable of recording Energy delivered to the Delivery Point.

**“Bankruptcy Code”** means the United States Bankruptcy Code (11 U.S.C. § 101 et seq.), as amended, and any successor statute.

**“Bid”** has the meaning set forth in the CAISO Tariff.

**“Business Day”** means any day other than a Saturday or Sunday or any other day on which banks in the State of California are permitted or required to remain closed.

**“Buyer Curtailment Order”** means a telephonic or automated instruction (it being acknowledged that Buyer shall endeavor to promptly confirm any such telephonic instructions in writing), which is issued by Buyer, in its sole discretion, for a reason other than those enumerated in the definition of Curtailment Period, directing that Seller: (1) reduce generation of Buyer’s Allocation of Energy from the Facility by an amount, in whole MW increments, and for the period of time set forth in such order; or (2) bid economically so that if the CAISO Locational Marginal Price (as defined in the CAISO Tariff) is below a threshold, Buyer’s Allocation of Energy is curtailed and is not delivered to the Delivery Point on Buyer’s behalf. For avoidance of doubt, Buyer’s communication to Seller to curtail a Facility for reasons enumerated in the definition of Curtailment Period shall not constitute a Buyer Curtailment Order.

**“Buyer Financial Security”** has the meaning set forth in Section 5.4 hereof.

**“Buyer’s Allocation”** means the allocation equal to the Contract Capacity divided by the Capacity (for example, if the Capacity is 250 MW, Buyer’s Allocation is equal to 50/250 or 20.0%); *provided, however*, that during any Settlement Interval in which a portion of the Capacity is curtailed, Buyer’s Allocation will be equal to the Available Contract Capacity for such Settlement Interval *less* the curtailed Capacity pursuant to a Buyer Curtailment Order, *divided by* the Available Capacity that has not been curtailed and is available to generate Product for such Settlement Interval. The Parties acknowledge and agree that in such instances, to the extent there is no curtailment due to a Buyer Curtailment Order, Seller may allocate an additional portion of the Spare Capacity to Buyer so long as the Available Contract Capacity does not exceed the Contract Capacity at any time (for example, if the Facility is curtailed during a Curtailment Period such that the Available Capacity is reduced to 125 MW, and Buyer’s Available Contract Capacity would be reduced to 25 MW, Seller could provide Buyer with additional Capacity (and related Energy) of up to 25 MW).

**“CAISO”** means the California Independent System Operator Corporation.

**“CAISO Penalties”** means any fees, liabilities, assessments, sanctions, penalties or similar charges assessed, or otherwise billed to a Party, by the CAISO.

**“CAISO Settlement Price”** means the Locational Marginal Price (as defined in the CAISO Tariff) at the Delivery Point for each Settlement Interval (as defined in the CAISO Tariff).

**“CAISO Tariff”** means the CAISO Operating Agreement and Tariff, Business Practice Manuals (BPMs), and Operating Procedures, including the rules, protocols, procedures and standards attached thereto, as the same may be amended, supplemented or replaced (in whole or in part) from time to time; provided if there is a conflict between the CAISO Operating Agreement and Tariff, and the BPM, the CAISO Operating Agreement and Tariff will control.

**“California Public Records Act”** means California Government Code Section 6250 *et seq.*, as amended or supplemented from time to time.

**“California Renewables Portfolio Standard”** means the renewable energy program and policies established and codified in California Public Utilities Code Sections 399.11, *et seq.* and California Public Resources Code Sections 25740 *et seq.*, as implemented by the CPUC and CEC, as such program and policies may be amended or supplemented from time to time.

**“Capacity”** means the maximum instantaneous electric generating capacity of the Facility, as measured at the Delivery Point (expressed in MW-AC) when operated in compliance with the Interconnection Agreements and consistent with the manufacturer’s recommended power factor and operating parameters, and as further defined in **Exhibits B and B-1**.

**“Capacity Rights”** means any current or future defined characteristic, certificate, tag, credit, ancillary service or attribute thereof, or accounting construct, including any of the same counted towards any current or future Resource Adequacy or reserve requirements, associated with the electric generation capability and Capacity of the Facility. Capacity Rights shall be deemed to include all Resource Adequacy benefits, if any, associated with the Facility and its Capacity. Capacity Rights are measured in MW and shall exclude Energy, Green Attributes, and any other tax incentives existing now or in the future associated with the construction, ownership or operation of the Facility.

**“CEC”** means the California Energy Commission.

**“CEC Certification and Verification”** means that the CEC has certified or pre-certified that the Facility is an ERR for purposes of the California Renewables Portfolio Standard and that all Energy produced by the Facility qualifies as generation from an ERR.

**“CIRA Tool”** means the CAISO Customer Interface for Resource Adequacy.



**“Cluster 8 Project”** means a project controlled by an Affiliate of Seller that has an interconnection queue position within the CAISO Cluster 8 application filing window.

**“Cluster 9 Project”** means a project controlled by an Affiliate of Seller that has an interconnection queue position within the CAISO Cluster 9 application filing window.

**“Commercial Operation”** means the status of the Facility upon Seller’s satisfaction of all of the conditions set forth in Section 2.6(a).

**“Commercial Operation Certificate”** is defined in Section 2.6(a) and shall be in the form attached hereto as **Exhibit J**.

**“Commercial Operation Date”** means, subject to Section 2.6(a), the date on which Commercial Operation has commenced.

**“Compliance Showings”** means Buyer’s compliance with the Resource Adequacy obligations of the CPUC for an applicable Showing Month.

**“Contract Capacity”** means Capacity of 50 MW-AC, which Seller shall make available to deliver Energy to Buyer during the Delivery Term.

**“Contract Price”** is set forth in **Exhibit A**.

**“Contract Year”** means a twelve (12) calendar-month period, with the first Contract Year commencing at 00:00 am PPT on the first day of the first full month following the Commercial Operation Date and each new Contract Year beginning on the anniversary date thereof.

**“Corporate Guaranty”** means a guaranty provided by a Qualified Guarantor and substantially in the form of **Exhibit D**.

**“Costs”** means, with respect to the non-defaulting Party, brokerage fees, commissions and other similar third party transaction costs and expenses (including costs incurred in connection with transmission services that would otherwise not have been incurred hereunder) reasonably incurred by such Party either in terminating any arrangement pursuant to which it has hedged its obligations or entering into new arrangements which replace this Agreement and all reasonable attorneys’ fees and expenses incurred by the non-defaulting Party in connection with the termination of this Agreement.

**“CPUC”** means the California Public Utilities Commission.

**“Credit Rating”** means, with respect to a Person, on any date of determination, (a) the ratings assigned by Moody’s, S&P or Fitch with respect to such Person’s long-term unsecured, senior indebtedness not supported by third party credit enhancement, or (b) if such Person does not have such a rating, then the rating assigned to such Person by Moody’s, S&P or Fitch as its corporate credit rating or issuer rating.

**“Curtailed Period”** means the period of time during which there is any reduction in Energy deliveries to the Delivery Point as a result of any of the following:

(a) The CAISO or other Governmental Authority orders, directs, alerts, or provides notice to a Party to curtail Energy deliveries for any reason;

(b) The Transmission Provider, or other Governmental Authority having similar authority or performing similar functions, orders, directs, alerts or provides notice to a Party to curtail Energy deliveries for any reason;

(c) Scheduled or unscheduled maintenance or construction on the CAISO, Transmission Provider, or other Governmental Authority’s transmission or distribution facilities that prevents Buyer from receiving Energy at, or Seller from delivering Energy to, the Delivery Point;

(d) A curtailment by a third party (*i.e.*, an entity other than Seller) pursuant to the Interconnection Agreements (or a curtailment by Seller pursuant to the Interconnection Agreements) solely in the event of an Emergency Condition as defined therein;

(e) Such reduction in Energy deliveries is the result of any of the following: (i) a Planned Outage or Forced Outage, (ii) an outage not constituting a Planned Outage or a Forced Outage undertaken to construct, install, maintain, repair, replace, remove or inspect any of its equipment or facilities or in connection with a condition likely to result in significant damage to Seller’s equipment or if Seller otherwise reasonably deems such curtailment necessary to protect life or property, (iii) because the interconnection between the Facility and Transmission Provider’s Transmission System is otherwise disconnected, suspended or interrupted, in whole or in part, pursuant to the Interconnection Agreements, or (iv) a Force Majeure Event that prevents either Party from delivering or receiving the Product;

(f) Seller, or Seller’s market designee, has received a notice from CAISO pursuant to CAISO Operating Procedure No. 2390 (or its successor) having the effect of requiring a reduction during the same time period that Seller, or Seller’s market designee submitted a Self-Schedule and/or an Energy Supply Bid (each as defined in the CAISO Tariff) that clears, in full, the applicable CAISO market for the full amount of Energy forecasted to be produced from the Facility for such time period.

**“Daily Delay Damages”** shall equal [REDACTED] per Day.

**“Day” or “day”** means a period of twenty-four (24) consecutive hours beginning at 00:00 hours Pacific Prevailing Time (PPT) on any calendar day and ending at 00:00 hours PPT on the next calendar day.

***“Debt Service Coverage Ratio”*** shall mean net operating income from all sources, including draws from reserves, divided by total debt obligations due within one year (including interest, principal, sinking-fund and lease payments).

***“Delivery Point”*** means the pricing node (i.e., ***“PNode”***), more specifically described in **Exhibit C**, where Seller’s Interconnection Facilities connect to the Transmission Provider’s Transmission System.

***“Delivery Term”*** means the period beginning at 00:00 am PPT on the first day of the first full month following the Commercial Operation Date and continuing through the end of the fifteenth (15th) anniversary thereof.

***“Downgrade Event”*** occurs if either (i) the lowest of the Credit Ratings of the Seller Guarantor or Buyer (as applicable): (A) is below “BBB-” with respect to S&P or (B) is below “Baa3” with respect to Moody’s or (ii) if Seller Guarantor or Buyer (as applicable), ceases to have a Credit Rating, by either Moody’s or S&P.

***“Electrical Losses”*** means all losses between the Facility and the Delivery Point, including any transmission or transformation losses between any of the Facility’s Meters and the Delivery Point.

***“Eligible Intermittent Resource Protocol”*** or ***“EIRP”*** means the Eligible Intermittent Resource Protocol, as may be amended from time to time, as set forth in the CAISO Tariff.

***“Eligible Renewable Energy Resource”*** or ***“ERR”*** has the meaning set forth in California Public Utilities Code Section 399.12, as may be amended or supplemented from time to time.

***“Emergency Condition”*** means a condition or situation:

(a) In the judgment of the Party making the claim, is imminently likely to endanger life or property, or is necessary to protect persons, or third parties’ property from damage or interference caused by the Facility or improperly operating protective devices;

(b) That, in the case of Seller, is imminently likely (as determined in a non-discriminatory manner) is to cause a material adverse impact on or damage to the security or operation of Seller’s Interconnection Facilities or the Facility;

(c) That will result in the Buyer being unable to meet specific FERC or NERC standards; or

(d) That is an abnormal system condition that requires automatic or immediate manual action to prevent or limit the failure of transmission/distribution facilities or generation supply that could adversely affect the reliability of the bulk electric or interconnecting utility systems.

For avoidance of doubt, the following are not Emergency Conditions: (i) Buyer's ability to purchase energy or Green Attributes at a lower price; or (ii) Buyer's inability to use or resell Energy or other generation.

**"Energy"** means the as-available, net electric energy output generated or discharged by the Facility, which shall exclude station use, auxiliary loads or other electric energy consumed by the Facility and shall be in the form of three (3)-phase, sixty (60) Hertz, alternating current.

**"Expected Energy"** means the Energy expected to be delivered to the Delivery Point for each Contract Year as specified in **Exhibit H**.

**"Excused Energy"** means Buyer's Allocation of Energy, expressed in MWh, that would have been produced by the Facility and made available at the Delivery Point, absent: (i) a Curtailment Period, except for a Curtailment Period that results from a Forced Outage or Planned Outage, (ii) a Buyer Curtailment Order, or (iii) a period of Seller suspension due to a Buyer Event of Default pursuant to Section 3.4(b)(ii). For avoidance of doubt, Energy that Seller would have produced and delivered but for a Forced Outage or Planned Outage shall not be counted as Excused Energy. The amount of Excused Energy shall be determined by Seller using the best information available at the time including weather conditions or physical limitations and any other factors relevant to the determination. Seller shall be responsible for collecting and archiving Site insolation in order to determine the Excused Energy for the Facility.

**"Facility"** means Seller's 250 MW-AC Aquamarine project, located in Kings County, California, together with any and all additions, replacements or modifications thereto, together with other electrical infrastructure, including metering, Seller Interconnection Facilities, SCADA System, and a step-up transformer(s), with a maximum generating Capacity for the Facility at the Delivery Point of 250 MW-AC, as more particularly described in **Exhibits B and B-1**.

**"Facility Construction"** means the start of construction for the Facility, as demonstrated by Seller's initiation of physical activities at the Site, including the movement of soil, at a sufficient level to reasonably demonstrate that Seller is preparing for the construction of the Facility.

**"Facility Operator"** means Seller or an Affiliate of Seller that operates the Facility.

**"FERC"** means the Federal Energy Regulatory Commission.

**"Force Majeure Event"** means any act of God (including fire, flood, earthquake, extremely severe storm, lightning strike, tornado, volcanic eruption, hurricane or other natural disaster), labor disturbance, strike or lockout of a national scope, act of the public enemy, war, insurrection, riot, explosion, terrorist activities or any order, regulation or restriction imposed by governmental, military, or lawfully established civilian authorities

that (i) prevents one Party from performing any of its obligations under this Agreement, (ii) could not reasonably be anticipated as of the Effective Date, (iii) is not within the reasonable control of, or the result of negligence, willful misconduct, breach of contract, intentional act or omission or wrongdoing on the part of the affected Party (or any subcontractor or Affiliate of that Party, or any Person under the control of that Party or any of its subcontractors or Affiliates, or any Person for whose acts such subcontractor or Affiliate is responsible), and (iv) by the exercise of due diligence the affected Party is unable to overcome or avoid or cause to be avoided; provided, nothing in clause (iv) shall be construed so as to require a Party to accede or agree to any provision not satisfactory to it in order to settle and terminate a strike or labor dispute in which it may be involved. Any Party rendered unable to fulfill any of its obligations by reason of a Force Majeure Event shall exercise due diligence to remove such inability with reasonable dispatch within a reasonable time period and mitigate the effects of the Force Majeure. The relief from performance shall be of no greater scope and of no longer duration than is required by the Force Majeure. Without limiting the generality of the foregoing, a Force Majeure Event does not include any of the following: (1) any requirement to meet an Applicable Law or any change (whether voluntary or mandatory) in any Applicable Law that may affect the value of the Product; (2) events arising from the failure by Seller to operate or maintain the Facility in accordance with this Agreement; (3) any increase of any kind in any cost of a Party to perform under this Agreement (except as expressly provided for otherwise herein); (4) delays in or inability of a Party to obtain financing or other economic hardship of any kind; (5) Seller's ability to sell any Product at a price in excess of those provided in this Agreement; (6) curtailment or other interruption of any Transmission Service, except due to Force Majeure; (7) failure of third parties to provide goods or services essential to a Party's performance, except due to Force Majeure; (8) Facility or equipment failure of any kind, except due to Force Majeure; or (9) any changes in the financial condition of Buyer, Seller, a Lender, or any subcontractor or supplier impacting the affected Party's ability to perform its obligations under this Agreement.

***"Forced Outage"*** means an unplanned reduction, interruption or suspension of the Facility's ability to generate or deliver Energy to the Delivery Point that is not the result of a Force Majeure Event or a Planned Outage.

***"Forward Certificate Transfer"*** has the meaning set forth in the WREGIS Operating Rules.

***"Full Capacity Deliverability Status"*** or ***"FCDS"*** has the meaning set forth in the CAISO Tariff.

***"GEP Damages"*** has the meaning set forth in Section 5.5(a).

***"Generator Operator"*** means an operator that meets the requirements of Generator Operator as defined by NERC in its Statement of Compliance Registry Criteria (Revision 6.0), as amended or in a successor document.

**“Governmental Authority”** means any supranational, federal, state or other political subdivision thereof, having jurisdiction over Seller, Buyer or this Agreement, including any municipality, township or county, and any entity or body exercising executive, legislative, judicial, regulatory or administrative functions of or pertaining to government, including any corporation or other entity owned or controlled by any of the foregoing. For purposes of this Agreement, the term Government Authority shall include FERC, NERC (if applicable), WECC, CAISO, CPUC and CEC.

**“Green Attributes”** means any and all credits, benefits, emissions reductions, offsets, and allowances, howsoever entitled, attributable to the generation of Energy from the Facility and its avoided emission of pollutants. Green Attributes include but are not limited to Renewable Energy Credits, as well as: (1) any avoided emission of pollutants to the air, soil or water such as sulfur oxides (Sox), nitrogen oxides (NOx), carbon monoxide (CO) and other pollutants; (2) any avoided emissions of carbon dioxide (CO<sub>2</sub>), methane (CH<sub>4</sub>), nitrous oxide, hydrofluorocarbons, perfluorocarbons, sulfur hexafluoride and other greenhouse gases (GHGs) that have been determined by the United Nations Intergovernmental Panel on Climate Change, or otherwise by law, to contribute to the actual or potential threat of altering the Earth’s climate by trapping heat in the atmosphere; (3) the reporting rights to these avoided emissions, such as Green Tag Reporting Rights. Green Tag Reporting Rights are the right of a Green Tag purchaser to report the ownership of accumulated Green Tags in compliance with federal or state law, if applicable, and to a federal or state agency or any other party at the Green Tag purchaser’s discretion, and include without limitation those Green Tag Reporting Rights accruing under Section 1605(b) of The Energy Policy Act of 1992 and any present or future federal, state, or local law, regulation or bill, and international or foreign emissions trading program. Green Tags are accumulated on a MWh basis and one Green Tag represents the Green Attributes associated with one (1) MWh of Energy. Green Attributes do not include (i) any energy, capacity, reliability or other power attributes from the Facility, (ii) investment tax credits, production tax credits associated with the ownership, construction or operation of the Facility and other financial incentives in the form of credits, reductions, or allowances associated with the Facility that are applicable to a tax obligation, (iii) fuel-related subsidies or “tipping fees” that may be paid to Seller to accept certain fuels, or local subsidies received by the generator for the destruction of particular preexisting pollutants or the promotion of local environmental benefits, or (iv) emission reduction credits encumbered or used by the Facility for compliance with local, state, or federal operating and/or air quality permits.

**“Guaranteed Commercial Operation Date”** has the meaning set forth in Section 2.5(e).

**“Guaranteed Construction Start Date”** has the meaning set forth in Section 2.5(d).

**“Guaranteed Contract Capacity Date”** has the meaning set forth in Section 2.5(f).

**“Interconnection Agreements”** means all (a) Large Generator Interconnection Agreements, (b) Distribution Service Agreements, (c) Transmission Service Agreements, (d) Participating Generator Agreements, and (e) Metering Service Agreements (as each

are defined in the CAISO Tariff) necessary for Seller to operate the Facility and delivery Energy to the Delivery Point in compliance with this Agreement.

**“Interconnection Point”** means the point of first point of interconnection of the Facility with the Transmission Provider’s Transmission System, as more fully described on **Exhibits B and B-1**.

**“Interim Deliverability Status” or “IDS”** means an interim designation allowing an Interconnection Customer that has requested Full Capacity Deliverability Status to obtain non-zero Net Qualifying Capacity, as determined annually by the CAISO pursuant to the provisions of the CAISO Tariff and the applicable Business Practice Manual, pending the in-service date of all the required Network Upgrades required for its requested Full Capacity Deliverability Status.

**“Investment Grade”** means a Credit Rating of at least “Baa3” with respect to Moody’s and at least “BBB-” with respect to S&P.

**“Lender”** means any and all Persons or successors in interest thereof, other than an Affiliate of Seller, (a) lending money or extending credit (whether directly to Seller or to an Affiliate of Seller) as follows: (i) for the construction, interim or permanent financing or refinancing of the Facility; (ii) for working capital or other ordinary business requirements of the Facility (including the maintenance, repair, replacement or improvement of the Facility); (iii) for any development financing, bridge financing, credit support, credit enhancement or interest rate protection in connection with the Facility; (iv) for any capital improvement or replacement related to the Facility; or (v) in connection with the financing of a portfolio of projects that includes the Facility; (b) participating (directly or indirectly) as a Tax Equity Investor; or (c) a lessor under a lease finance arrangement of the Facility.

**“Lender Consent”** means a consent substantially in the form of **Exhibit E**, with such modifications as may be reasonably requested by Lenders, subject to Buyer’s reasonable approval.

**“Letter of Credit”** means one or more irrevocable, non-transferable standby letters of credit issued by a Qualified Institution and substantially in the form of **Exhibit G**.

**“Losses”** means, with respect to the non-defaulting Party, an amount equal to the present value of the economic loss to it (if any), exclusive of Costs, resulting from termination of this Agreement, determined in a commercially reasonable manner, which economic loss (if any) shall be the loss (if any) to such Party represented by the difference (if any) between the present value of the payments required to be made during the remaining Term of this Agreement and the present value of the payments that would be required to be made under transaction(s) replacing this Agreement. The non-defaulting Party’s Losses shall be zero (\$0) if such Party receives an economic benefit due to the termination of this Agreement. If the non-defaulting Party is the Seller, then Losses shall exclude any loss of the PTC, or other federal or state tax credits, grants, or benefits related to the Facility or generation therefrom.

**“Meter”** means the revenue quality meters, data processing gateways or remote intelligence gateways, telemetering equipment and data acquisition services that are dedicated to the Facility and are sufficient for monitoring, recording and reporting, in real time, all Energy from the Facility, as required and specified in the CAISO Tariff.

**“Milestone Schedule”** means Seller’s schedule to develop the Facility, as set forth in Exhibit I.

**“Minimum Annual Energy Production”** means for each Contract Year the quantity of Energy specified in Exhibit F.

**“Moody’s”** means Moody’s Investor Service, Inc.

**“MW”** means a megawatt.

**“MWh”** means a megawatt hour.

**“NERC”** means the North American Electric Reliability Corporation.

**“NERC Reliability Standards”** means standards and rules that are adopted by NERC or WECC and approved by the applicable Governmental Authorities.

**“Net Qualifying Capacity”** or **“NQC”** has the meaning set forth in the CAISO Tariff.

**“Notification Deadline”** is twenty (20) Business Days before the relevant deadlines for the corresponding Compliance Showings applicable to the relevant Showing Month.

**“Pacific Prevailing Time”** or **“PPT”** means the prevailing standard time or daylight savings time, as applicable, in the Pacific time zone.

**“Performance Period”** means each two (2) consecutive Contract Years commencing with the first Contract Year so that the first Performance Period shall include Contract Years 1 and 2. For the avoidance of doubt, Performance Periods shall overlap, so that if the first Performance Period is comprised of Contract Years 1 and 2, the second Performance Period shall be comprised of Contract Years 2 and 3, the third Performance Measurement Period shall be comprised of Contract Years 3 and 4, and so on; provided however that a new Performance Period shall begin following any Performance Period in which there is a Shortfall Amount. Thus, for example, if there is a Shortfall Amount for the Performance Period that is comprised of Contract Years 4 and 5, the next Performance Measurement Period shall be comprised of Contract Years 6 and 7.

**“Permits”** means all applications, approvals, authorizations, consents, filings, licenses, orders, permits or similar requirements imposed by any Governmental Authority in order to develop, construct, operate, maintain, improve, refurbish and retire the Facility or to forecast or deliver the Product produced by the Facility to Buyer at the Delivery Point.



**“Person”** means an individual, partnership, corporation, business trust, joint stock company, trust, unincorporated association, joint venture, governmental entity, limited liability company or any other entity of whatever nature.

**“Planned Outage”** means an interruption of all or a portion of the Facility’s capability to generate or deliver Energy to the Delivery Point that is scheduled in the Outage Schedule delivered to Buyer pursuant to Section 2.9(d)(ii) and is required for inspection, preventive maintenance or corrective maintenance of the Facility.

**“Prime Rate”** means the interest rate (sometimes referred to as the “base rate”) for large commercial loans to creditworthy entities announced from time to time by Citibank, N.A. (New York), or its successor bank, or, if such rate is not announced, the rate published in The Wall Street Journal as the “Prime Rate” from time to time (or, if more than one rate is published, the arithmetic average of such rates), in either case determined as of the date the obligation to pay interest arises, but in no event more than the maximum rate permitted by Applicable Law.

**“Product”** means (i) Buyer’s Allocation of all of the Energy produced by the Facility and delivered to the Delivery Point, (ii) all of the Green Attributes and Renewable Energy Credits associated with the Energy purchased by Buyer, and (iii) all of the Capacity Rights, as well as any ancillary services associated with the Contract Capacity.

**“Prudent Operating Practices”** means the practices, methods and standards of professional care, skill and diligence engaged in or approved by a significant portion of the solar electric generation industry that, in the exercise of reasonable judgment, in light of the facts known at the time, would have been expected to accomplish results consistent with Applicable Law, reliability, safety, environmental protection and standards of economy and expedition.

**“Qualified Guarantor”** means the Seller-affiliated entity that has maintained a senior unsecured long-term debt rating that meets at least two of the following: “BBB-” or better by S&P; “BBB-” or better by Fitch; or “Baa3” or better by Moody’s.

**“Qualified Institution”** means a major U.S. commercial bank or a foreign bank with a U.S. branch office with a Credit Rating of at least “A-” by S&P and “A3” by Moody’s (without a “credit watch”, “negative outlook” or other rating decline alert if its’ Credit Rating is “A-” by S&P or “A3” by Moody’s), and having assets of at least ten billion dollars (\$10,000,000,000.00).

**“Qualifying Capacity”** has the meaning set forth in the CAISO Tariff.

**“Qualifying Credit Support”** means financial and credit conditions that Buyer may maintain in accordance with Section 5.4 in order to qualify for the corresponding Contract Price as set forth in Exhibit A.

**“Renewable Energy Credit”** has the meaning set forth in California Public Utilities Code Section 399.12(h) and CPUC Decision 08-08-028, as may be amended from time to time or as further defined or supplemented by Applicable Law.

**“Replacement RA”** means Resource Adequacy benefits, if any, equivalent to those that would have been provided by the Facility with respect to the NQC associated with Buyer’s Allocation of Capacity Rights for the applicable month. Replacement RA shall not be provided from any generating unit that utilizes coal or coal materials as a source of fuel.

**“Resource Adequacy” or “RA”** means the procurement obligation of load serving entities, as such obligations are described in CPUC Decisions D.04-10-035 and D.05-10-042 and subsequent CPUC decisions addressing Resource Adequacy issues, as those obligations may be altered from time to time in the CPUC Resource Adequacy Rulemakings (R.) 04-04-003, R.05-12-013, R.08-01-025, R.09-10-032, R.10-04-012, R.11-10-023, R.14-10-010, and R.17-09-020 or by any successor proceeding, and the Resource Adequacy supply obligations of generators provided in the CAISO Tariff, including Section 40 of such Tariff, taking into account any CPUC or CAISO process to establish or determine NQC.

**“Resource Adequacy Plan”** has the meaning set forth in the CAISO Tariff.

**“SCADA System”** means the automated system that meters and collects: (a) availability and power generation from the Facility; (b) solar irradiance, temperature and pressure from the Meteorological Station; and, (c) other operational parameters describing the state of the Facility.

**“Scheduling Coordinator” or “SC”** means an entity certified by the CAISO as qualifying as a Scheduling Coordinator pursuant to the CAISO Tariff for the purposes of undertaking the functions specified in “Responsibilities of a Scheduling Coordinator” as set forth in the CAISO Tariff, as amended from time to time.

**“Seller’s Interconnection Facilities”** means all of the interconnection facilities, control and protective devices, distribution facilities, metering facilities and other equipment and facilities, whether or not the facilities, devices and equipment are owned by Seller, required to connect the Facility with the Transmission Provider’s Interconnection Facilities or Transmission Provider’s Transmission System located up to, and on Seller’s side of, the Delivery Point, including any modification, addition or upgrades to such facilities.

**“Showing Month”** means the calendar month of the Delivery Term that is the subject of the related Compliance Showing.

**“Site”** means the real property located in Kings County, California on which the Facility is located, as more fully described on **Exhibits B and B-1**.

**“Site Control”** means that Seller has the right to utilize the Site for the construction and operation of the Facility during the Term pursuant to option(s), lease(s), easement(s) or other legal instrument(s), or any combination thereof.

**“Spare Capacity”** means any Available Capacity from the Facility that has not otherwise been committed by Seller to any third party under a power sales agreement.

**“S&P”** means Standard and Poor’s Ratings Group (a division of McGraw Hill Inc.).

**“Supply Plan”** has the meaning set forth in the CAISO Tariff.

**“Tax Equity Investor”** means an equity investor in the Facility that is not an Affiliate of Seller, and whose investment in the Facility is intended to be consistent with the “Safe Harbor” for solar transactions under Revenue Procedure 2007-65 and Announcement 2009-69.

**“Termination Payment”** means an amount calculated in a manner consistent with Section 3.4(c)(ii).

**“Transmission Provider”** means Pacific Gas & Electric Company, or its successor, in its capacity as owner of the facilities used for the transmission or distribution of electric energy at or from the Interconnection Point.

**“Transmission Provider’s Interconnection Facilities”** means all facilities and equipment owned by the Transmission Provider and controlled or operated by CAISO, required to connect the Transmission Provider’s Transmission System with the Facility up to, and on the Transmission Provider’s side of, the Interconnection Point.

**“Transmission Provider’s Transmission System”** means the facilities owned or operated by the Transmission Provider, and controlled by CAISO, for the transmission of electric energy from the Interconnection Point.

**“WECC”** means the Western Electricity Coordinating Council.

**“WREGIS”** means the Western Renewable Energy Generating Information System or any successor program that may be implemented to track and record compliance with the California Renewable Portfolio Standard.

**“WREGIS Certificates”** has the same meaning as “Certificate” as defined by WREGIS in the WREGIS Operating Rules and are designated as eligible for complying with the California Renewables Portfolio Standard.

**“WREGIS Operating Rules”** means those operating rules and requirements dated December 2010, as subsequently amended, supplemented or replaced (in whole or in part) from time to time.

**ARTICLE 2**  
**SALE AND PURCHASE OF ENERGY**

**2.1 *Purchase and Sale of Energy.***

(a) At all times during the Delivery Term, Seller shall sell and deliver to Buyer at the Delivery Point, and Buyer shall purchase and accept from Seller at the Delivery Point, Buyer's Allocation of the Energy generated by the Facility.

(b) Notwithstanding the foregoing:

(i) Seller's obligation to sell and deliver Buyer's Allocation of Energy to Buyer at the Delivery Point shall be excused during the pendency of, and to the extent required by (A) a Force Majeure Event, (B) a Buyer Curtailment Order, (C) a Curtailment Period, provided such Curtailment Period is not attributable to Seller's breach of its obligations under this Agreement or the Interconnection Agreements, or (D) a period of Seller suspension pursuant to Section 3.4(b)(ii) due to a Buyer Event of Default.

(ii) Buyer's obligation to accept Buyer's Allocation of Energy at the Delivery Point shall be excused during the pendency of, and to the extent required by (A) a Force Majeure Event, (B) a Buyer Curtailment Order, (C) a Curtailment Period, provided such Curtailment Period is not attributable to Buyer's breach of its obligations under this Agreement, or (D) a period of Buyer suspension pursuant to Section 3.4(b)(ii) due to a Seller Event of Default.

(iii) Buyer's obligation to purchase Buyer's Allocation of Energy from Seller under this Agreement shall be excused during the pendency of, and to the extent required by (A) a Force Majeure Event, (B) a Curtailment Period, provided such Curtailment Period is not attributable to Buyer's breach of its obligations under this Agreement, or (C) a period of Buyer suspension pursuant to Section 3.4(b)(ii) due to a Seller Event of Default.

(c) During the time period, if any, beginning on the day the Facility is first energized and operated in parallel with the Transmission Provider's Transmission System and delivers metered Energy to the Delivery Point and up to the Commercial Operation Date, Seller may sell and deliver to Buyer and Buyer shall purchase and accept Buyer's Allocation of such Energy at no net cost to Buyer, meaning that Seller shall be responsible for paying all charges and fees associated with the scheduling and delivery of such Energy deliveries and Seller shall receive the CAISO Settlement Price (whether positive or negative) with respect to such Energy deliveries.

**2.2 *Contract Price.***

(a) During the Delivery Term, Buyer shall pay Seller the Contract Price (as set forth in **Exhibit A**) for: (i) each MWh of Buyer's Allocation of Energy that Seller delivers to the Delivery Point from the Facility (which deliveries shall be adjusted to reflect Electrical Losses in accordance with Section 4.2(a)), and (ii) each MWh of Available Energy that Seller would have generated and delivered to the Delivery Point from the Facility but for a Buyer Curtailment Order. The Contract Price is intended to compensate Seller for all Product and shall become applicable on the Commercial Operation Date.

(b) **Excess Energy.** During the Delivery Term, the Contract Price for Buyer's Allocation of Energy, if any, that is delivered in excess of the Contract Capacity during any Settlement Interval (as defined in the CAISO Tariff) ("Excess Energy") shall be zero dollars (\$0). If the CAISO Settlement Price is negative for a Settlement Interval during which Excess Energy is delivered, Seller shall pay Buyer an amount equal to the product of (i) the absolute value of the CAISO Settlement Price, and (ii) the quantity of Excess Energy.

(c) **Transfer Taxes.** In addition to the amounts otherwise payable by Buyer in accordance with this Section 2.2, Buyer shall pay (and shall indemnify and hold Seller harmless on an After-Tax Basis from and against) all sales, use, excise, ad valorem, transfer and other similar taxes arising out of or with respect to the purchase or sale or use of Product ("Transfer Taxes"), but excluding all taxes based on or measured by net income, that are imposed by any taxing authority arising out of or with respect to the purchase or sale of Product (regardless of whether such Transfer Taxes are imposed on Buyer or Seller), together with any interest, penalties or additions to tax payable with respect to such Transfer Taxes. Seller shall be responsible for any taxes on generation of solar energy, taxes on Seller's income from Facility operations, property taxes or special assessments that may be levied upon the Facility, and state or local sales taxes applicable to the construction, maintenance, repair or operation of the Facility. Each Party shall use reasonable efforts to implement the provisions of and to administer this Agreement in accordance with the intent of the Parties to minimize all taxes, so long as neither Party is materially adversely affected by such efforts.

### **2.3 Dedication of Product to Buyer.**

Except as otherwise provided for herein, Seller shall not assign, transfer, convey, encumber, sell, or otherwise dispose of all or any portion of the Product to any person other than Buyer during the Term. During the Term, Seller shall not deliver, or attempt to schedule or deliver, energy to the Delivery Point to satisfy its obligations under this Agreement that was not generated by or attributable to the Facility or the facilities identified on **Exhibit K** attached hereto, which include Cluster 8 Projects, Cluster 9 Projects, and adjacent projects with the same Interconnection Point to be developed by Seller or an affiliate thereof.

### **2.4 Purchase and Sale of Green Attributes; Tax Credits.**

(a) Buyer shall be entitled to all Green Attributes resulting from the generation of Energy purchased by Buyer pursuant to this Agreement. The consideration for all such Green Attributes is included within the Contract Price. Buyer shall not be entitled to any Renewable Energy Credits or Green Attributes from the generation of Energy that Buyer, for any reason, does not purchase under this Agreement.

(b) Title to the Green Attributes shall pass from Seller to Buyer free and clear of all liens, security interests, claims and encumbrances immediately upon the generation of the associated Energy at the Facility that gives rise to such Green Attributes. Seller shall not report under § 1605(b) of the Energy Policy Act of 1992 or under any applicable program that any of the Green Attributes purchased by Buyer hereunder belong to any person other than Buyer.

(c) At all times during the Delivery Term, Seller shall, at its sole cost, cause the

Facility to be registered with WREGIS; implement and maintain all necessary generation information communications required by WREGIS Operating Rules; and report generation information to WREGIS pursuant to WREGIS-approved meters that are dedicated to the Facility and only the Facility. Buyer has established a general account number with WREGIS (WREGIS Account Holder ID 1408). Within thirty (30) Business Days following the commencement of the Delivery Term, Seller shall, at its sole cost: (i) transfer to Buyer's WREGIS account any and all WREGIS Certificates associated with Renewable Energy Credits corresponding to that Energy generated by the Facility and purchased by Buyer, and (ii) pursuant to Section 15.5 of the WREGIS Operating Rules, register a Forward Certificate Transfer to Buyer's WREGIS account for the percentage of WREGIS Certificates reflecting Buyer's Allocation of the Renewable Energy Credits generated by the Facility during the Delivery Term, which Forward Certificate Transfer shall be effective for the remainder of the Delivery Term. Buyer shall comply with all WREGIS notice, reporting and other requirements with respect to Green Attributes it purchases from Seller and the Forward Certificate Transfer; *provided*, that Seller shall provide promptly to Buyer that Facility data and information reasonably necessary in order for Buyer to comply with such WREGIS requirements. Upon termination or expiration of this Agreement, Seller shall rescind the Forward Certificate Transfer and Buyer shall promptly assign and transfer back to Seller any Green Attributes existing in Buyer's WREGIS account not associated with Energy purchased and paid for by Buyer.

(d) Seller shall cooperate reasonably with Buyer, at Buyer's expense:

(i) In order for Buyer to register, hold, and manage such Green Attributes in Buyer's own name and to Buyer's accounts, including any rights associated with any renewable energy information or tracking system other than WREGIS that may be established with regard to monitoring, tracking, certifying, or trading such Green Attributes; and

(ii) In any registration by Buyer of the Facility in the renewable portfolio standard or equivalent program in states other than California and other non-California programs in which Buyer may wish to register or maintain registration of the Facility by providing copies of all such information as Buyer reasonably requests for such registration.

(e) Seller shall be entitled to all production or investment tax credits that are or will be generated by the Facility associated with the Energy purchased by Buyer.

## **2.5 *New Generation Facility.***

(a) Construction and Operation of the Facility. Seller shall: (i) undertake the design and construct the Facility in order to meet its obligations as contemplated herein; (ii) pay all fees, costs, and charges associated with interconnecting the Facility with the Transmission Provider's Transmission System; (iii) acquire and maintain all Permits and other approvals from Governmental Authorities necessary to construct, operate, and maintain the Facility throughout the Term; and (iv) complete, update, and maintain all environmental impact and plant and wildlife impact studies and mitigation necessary to construct operate, and maintain the Facility, including all impact studies and mitigation required under the California Environmental Quality Act.

(b) Maximum Capacity. Seller shall not increase the Contract Capacity beyond 50 MW-AC as measured at the Delivery Point without Buyer's prior written consent, which may be withheld in Buyer's sole and absolute discretion.

(c) Milestone Schedule Reporting. Seller shall use commercially reasonable efforts to meet the Milestone Schedule and to avoid or minimize any delays in meeting such schedule. Within ten (10) Days after the end of each month after the Effective Date and until the Commercial Operation Date, Seller shall provide Buyer a monthly written report of its progress toward meeting the Milestone Schedule in a form substantially similar to **Attachment A of Exhibit I**. Seller shall advise Buyer as soon as reasonably practicable of any problems or issues of which Seller is aware that may impact Seller's ability to meet the Milestone Schedule.

(d) Guaranteed Construction Start Date. Seller shall use commercially reasonable efforts to initiate Facility Construction no later than May 31, 2020 (the "Guaranteed Construction Start Date"). If Seller has not initiated Facility Construction on or prior to the Guaranteed Construction Date, after giving effect to all Permitted Extensions, then Seller shall pay to Buyer liquidated damages equal to Daily Delay Damages for each day until such time as Facility Construction is initiated. Seller shall pay Daily Delay Damages to Buyer in advance, on a monthly basis, for each full month during which any Daily Delay Damages will be due. A prorated amount shall be returned to Seller if Seller initiates Facility Construction during a month for which Daily Delay Damages were paid in advance. In the event that Seller achieves Commercial Operation on or before the Guaranteed Commercial Operation Date, Buyer shall return any previously paid Daily Delay Damages resulting from Seller's failure to initiate Facility Construction on or prior to the Guaranteed Construction Date.

(e) Guaranteed Commercial Operation Date. Seller shall have demonstrated Commercial Operation no later than September 24, 2021 (the "Guaranteed Commercial Operation Date"). If Commercial Operation has not occurred on or prior to the Guaranteed Commercial Operation Date, after giving effect to all Permitted Extensions, then Seller shall pay to Buyer liquidated damages equal to Daily Delay Damages for each day until such time as Commercial Operation is achieved. Seller shall pay Daily Delay Damages to Buyer in advance, on a monthly basis, for each full month during which any Daily Delay Damages will be due. A prorated amount shall be returned to Seller if Commercial Operation is achieved during a month for which Daily Delay Damages were paid in advance.

(f) Guaranteed Contract Capacity Date. Seller shall have demonstrated Commercial Operation of the full Contract Capacity of the Facility no later than October 30, 2021 (the "Guaranteed Contract Capacity Date"). Seller shall demonstrate Commercial Operation of the full Contract Capacity of the Facility by satisfying the conditions precedent in Section 2.6(a)(ii)-(vi) with respect to the full Contract Capacity. If Seller fails to demonstrate Commercial Operation of the full Contract Capacity on or prior to the Guaranteed Contract Capacity Date, after giving effect to all Permitted Extensions, then Seller shall pay to Buyer liquidated damages equal to one hundred thousand dollars (\$100,000) for each MW, or fraction thereof, of Contract Capacity that fails to reach Commercial Operation by the Guaranteed Contract Capacity Date (the "Contract Capacity Damages").

(g) Permitted Extensions. If Seller complies with Section 2.5(g)(i), the Guaranteed Construction Start Date, the Guaranteed Commercial Operation Date, and the Guaranteed Contract Capacity Date, as applicable, may each be extended on a day-for-day basis: (i) for a time period no longer than one-hundred eighty (180) days as a result of a Force Majeure Event or due to a delay caused by transmission provider (e.g., the CAISO), transmission owner, or Buyer through no fault of Seller; and (ii) for a time period no longer than three-hundred and sixty (360) days for a delay due to action or inaction by a Government Authority, through no fault of Seller, that prevents Seller from obtaining Permits or Government Approvals required for the operation of the Facility (together (i) and (ii) shall be considered “Permitted Extensions”). Any Permitted Extensions allowed pursuant to (i) and (ii) shall run concurrently such that total day-for-day extensions shall be no longer than three-hundred and sixty (360) days on a cumulative basis; provided that such Permitted Extensions shall only be granted so long as Seller has used commercially reasonable efforts (including but not limited to Seller’s timely filing of required documents and payment of all applicable fees) to overcome the cause of such Permitted Extension.

(i) In order to secure a Permitted Extension, Seller shall provide Buyer written notice within ten (10) Business Days of Seller becoming aware of the facts or circumstances giving rise to the Permitted Extension. Such notice must clearly identify the reason for the Permitted Extension being claimed, including the extent and anticipated period of delay. In order to secure a Permitted Extension, Seller shall provide Buyer written notice within ten (10) Days of Seller becoming aware of the facts or circumstances giving rise to the Permitted Extension. Such notice must clearly identify the reason for the Permitted Extension being claimed, including the extent and anticipated period of delay to the Guaranteed Construction Start Date, the Guaranteed Commercial Operation Date, or the Guaranteed Contract Capacity Date, as applicable.

(h) Liquidated Damages. Each Party agrees and acknowledges that the damages Buyer would incur due to Seller’s failure to initiate Facility Construction by the Guaranteed Construction Start Date, or Seller’s failure to achieve Commercial Operation by the Guaranteed Commercial Operation Date, or Seller’s failure to install the full Contract Capacity by the Guaranteed Contract Capacity Date would be difficult or impossible to determine, or obtaining an adequate remedy would be unreasonably time consuming or expensive, and therefore the Parties agree that Daily Delay Damages and Contract Capacity Damages are an appropriate approximation of such damages. Buyer shall have the right to set off any Daily Delay Damages and Contract Capacity Damages against payments due to Seller.

## **2.6 Commercial Operation.**

(a) Commercial Operation Date. The Commercial Operation Date shall be a date no sooner than January 1, 2020 that is selected by Seller; provided that on or prior to the Commercial Operation Date, Seller shall have completed all the following conditions precedent:

(i) Seller has provided to Buyer a certificate signed by an officer of Seller in the form attached hereto as **Exhibit J** (“Commercial Operation Certificate”), certifying that all requirements of this Section 2.6(a) have been completed;



(ii) Seller has obtained Site Control necessary to operate the Facility in accordance with this Agreement and has provided evidence of such Site Control to Buyer;

(iii) Seller has successfully completed commissioning of the Facility's equipment in accordance with applicable manufacturers' specifications;

(iv) Seller has successfully completed all testing required by Prudent Operating Practices or any requirement of law necessary to operate the Facility's Equipment;

(v) Seller has satisfied all Interconnection Agreement requirements necessary to deliver Energy to the Delivery Point, such Interconnection Agreements are in full force and effect, and the CAISO has authorized Energy deliveries from the Facility to the Delivery Point;

(vi) Seller has obtained all applicable Permits and approvals required to be obtained from any Governmental Authority to operate the Facility in compliance with Applicable Law and this Agreement, and such Permits and approvals are in full force and effect;

(vii) Seller has installed and commissioned Facility Capacity sufficient for Buyer's Allocation of the Capacity to equal at least ninety-five percent (95%) of the Contract Capacity;

(viii) Seller has satisfied the Insurance Obligations in Section 6.2, and Seller has provided evidence of such insurance to Buyer; and

(ix) Seller has delivered to Buyer the Operating Security.

(b) Seller shall provide notice of expected Commercial Operation to Buyer in writing no less than thirty (30) days in advance of such date. Seller shall provide the Commercial Operation Certificate and all documentation required in Section 2.6(a) to Buyer when Seller believes it has met the conditions for achieving Commercial Operation. Buyer shall have five (5) Business Days to provide Seller with written notice acknowledging or disputing that Commercial Operation has been achieved. In the event Buyer disputes that Commercial Operation has been achieved, Buyer's written notice shall state the basis for such dispute in reasonable detail and the matter shall be subject to the dispute resolution procedures in Section 8.16. Buyer's failure to respond in writing within five (5) days of Seller's delivery of the Commercial Operation Certificate shall be deemed notice of acceptance that Commercial Operation has been achieved. Upon Buyer's written acknowledgement, the Commercial Operation Date shall be the date of Seller's delivery to Buyer of the Commercial Operation Certificate, or the date upon which outstanding issues related to the satisfaction of the conditions in Section 2.6(a) have been resolved.

## **2.7 Title; Risk of Loss.**

Seller shall hold all rights, title and interest to all Product which Seller has conveyed to Buyer hereunder. Title to and risk of loss with respect to any Energy purchased by and delivered to Buyer by Seller in accordance with this Agreement shall pass from Seller to Buyer at the Delivery Point, and such Energy shall be free and clear of all liens, security interests, claims and

encumbrances or any interest therein or thereto by any other Person at the time of Seller's delivery. Until title passes, Seller shall be deemed in exclusive control of the same and shall be responsible for any damage or injury caused thereby. After title to Product passes to Buyer, as between the Parties, Buyer shall be deemed in exclusive control of such Product and shall be responsible for any damage or injury caused thereby. Seller shall bear all risks, financial and otherwise throughout the Term, associated with Seller's or the Facility's eligibility to receive incentive or other tax benefits, or qualify for accelerated depreciation for Seller's accounting, reporting or tax purposes. The obligations of the Parties hereunder, including those obligations set forth herein regarding the purchase and price for and Seller's obligation to deliver Product, shall be effective regardless of whether the Seller is eligible for, or receives, incentive tax credits or any other tax benefits.

## **2.8 *Transmission; CAISO Payments and Charges; Curtailment.***

(a) Seller's Transmission Service Obligations. Prior to the Commercial Operation Date and at all times during the Delivery Term:

(i) Seller shall deliver all Energy to the Delivery Point, and Seller shall arrange and pay for any and all facilities and transmission services (and any regulatory approvals required for the foregoing) that are necessary for Seller to deliver Energy to Buyer at the Delivery Point, including all of Seller's Interconnection Facilities and Transmission Provider's Interconnection Facilities.

(ii) Except as agreed otherwise in this Agreement, including in Section 2.8(b) and (c) and Section 7.3 hereof, Seller shall bear all risks, fees, costs, and charges associated with or imposed on transmission of Energy to the Delivery Point, including, but not limited to, any Electrical Losses, outages or curtailment of Energy deliveries, CAISO costs, CAISO Penalties, congestion, scheduling deviation, energy imbalance, and neutrality allocations associated with or imposed on transmission of Energy to the Delivery Point.

(iii) Seller shall comply with all contractual, metering and applicable interconnection requirements, including those set forth in the Interconnection Agreements, Transmission Provider's applicable tariffs, the CAISO Tariff, and implementing CAISO standards and requirements, so as to be able to deliver Energy to the Delivery Point.

(b) CAISO Payments and Charges. Buyer shall be entitled to all CAISO payments, and shall be responsible for CAISO charges associated with Buyer's Allocation of Energy, except that Seller shall: (1) be entitled to any CAISO revenues generated as a result of any five minute interval where the Uninstructed Imbalance Energy quantity is negative; and (2) be responsible for (A) any administrative charges, penalties, or fees assessed by the CAISO to the Facility solely in its capacity as a generator in the CAISO market (including the Forecast Fee(s) and Grid Management Charge(s) as defined in the CASIO Tariff), (B) any costs, charges and penalties assessed by the CAISO resulting from any five minute interval where the Uninstructed Imbalance Energy quantity is negative; (C) any CAISO charges, penalties, or fees related to Seller's failure to comply with a Dispatch Down Instruction (as defined in the CAISO Tariff) or a Buyer Curtailment Order, as provided in Section 2.8 (c)(iii); and (D) any CAISO charges due to Seller's failure to comply with the CAISO Tariff, except for those charges Buyer has agreed to

pay in this Agreement.

(c) Curtailment. Seller shall fully or partially curtail deliveries of Energy to Buyer during, and to the extent required by, a Curtailment Period or a Buyer Curtailment Order.

(i) Curtailment Periods. During any Curtailment Period, Seller shall curtail the generation or delivery of Energy from the Facility as directed by CAISO, the Transmission Provider, or a Governmental Authority, or as such reductions or curtailments are communicated to Seller by Buyer at the direction of CAISO, the Transmission Provider, or a Governmental Authority. If Seller delivers Energy that is not compliant with a direction to curtail generation or delivery of Energy during a Curtailment Period, Buyer shall not be required to pay Seller for Seller's non-compliant Energy deliveries. To the extent an event arises that causes Seller to curtail Energy deliveries to Buyer at the Delivery Point, Seller shall use commercially reasonable efforts to minimize the extent, amount and duration of any such curtailments.

(ii) Buyer Curtailment Orders. Buyer shall have the right to order Seller to reduce generation or delivery of Buyer's Allocation of Energy from the Facility pursuant to a Buyer Curtailment Order; provided: (i) Buyer shall give Seller (and Seller's SC, if applicable) not less than thirty (30) minutes' notice prior to the requested curtailment; (ii) such Buyer Curtailment Order does not violate the manufacturer's operating limits of the Facility's equipment in which case Seller may refuse to implement such curtailment in such time frame without any liability to Buyer; provided, Seller must continue to curtail Energy in a manner that is consistent with such operating limits; (iii) Buyer shall pay Seller for all Available Energy not delivered to Buyer due to a Buyer Curtailment Order in accordance with Section 2.2(a); and (iv) Buyer shall assume all liability, be responsible for, and hold harmless Seller, for any and all CAISO Penalties, other penalties, costs or charges incurred by Seller due to a Buyer Curtailment Order. Seller shall use commercially reasonable efforts to design and construct the Facility so that it has the ability to respond to a dispatch control signal in order to facilitate Buyer Curtailment Orders. If Seller delivers Energy that is not compliant with a Buyer Curtailment Order, Buyer shall not be required to pay Seller for Seller's non-compliant Energy deliveries. Seller shall, within one hundred and eighty (180) days of the expected Commercial Operation Date, provide Buyer with the operating limits for the Facility's equipment.

(iii) Seller Failure to Curtail. Notwithstanding the foregoing, if Seller fails to curtail deliveries of Energy during a Curtailment Period, or if Seller fails to curtail deliveries of Buyer's Allocation of Energy in accordance with a Buyer Curtailment Order, Seller shall assume all liability, be responsible for, and hold harmless Buyer, for any and all CAISO Penalties, other penalties, costs or charges incurred by Buyer due to Seller's failure to curtail, including payment for any negative CAISO Settlement Price associated with Energy deliveries that are not compliant with a Curtailment Order or Buyer Curtailment Order. In the event any such penalties, costs or charges are incurred by Buyer due to Seller's failure to curtail, Buyer shall provide Seller with a written invoice and supporting documentation with respect to any amounts due, and Seller shall pay such amounts within thirty (30) days of receipt of the invoice. Any disputes with respect to such amounts shall be resolved in accordance with Section 8.16 hereof.

**2.9 Scheduling; Forecasting; EIRP; Outage Notification.**

(a) Scheduling Coordinator. During the Delivery Term, Seller, at its sole cost, shall act as or select a Scheduling Coordinator for the Facility. In that regard, Buyer and Seller agree to the following:

(i) Designation as Scheduling Coordinator. When Seller designates a Scheduling Coordinator, then Seller shall give Buyer notice of such designation at least ten (10) Business Days before Seller's SC assumes Scheduling Coordinator duties hereunder, and Buyer shall be entitled to rely on such designation until it is revoked or a new Seller's SC is appointed by Seller upon similar notice. Seller shall be fully responsible for all acts and omissions of Seller's SC and shall indemnify Buyer for all CAISO Penalties, costs, charges and liabilities incurred by the Buyer.

(ii) Seller's Responsibilities as Scheduling Coordinator. As soon as it is authorized to act as the Facility's Scheduling Coordinator, Seller (or Seller's SC) shall comply with all obligations under the CAISO Tariff and shall conduct all scheduling and bid submissions in full compliance with the terms and conditions of this Agreement and the CAISO's protocol and scheduling practices, including the requirements of EIRP, if applicable (the "Scheduling Procedures"). Upon Buyer's request, Seller shall, within five (5) Business Days of such request, provide to Buyer any supporting documentation necessary for Buyer to audit and verify matters related to Seller's or Seller's SC's bids of the Facility into the CAISO market. Except as provided herein or to the extent attributable to Buyer's acts or omissions, Seller shall be responsible for the payment of all charges associated with its scheduling activities, including all charges assessed by the CAISO (including CAISO Penalties) with respect to Seller's scheduling of Energy.

(iii) Buyer shall have the right from time to time during the Term, at Buyer's sole cost and expense, to enter into contracts with solar forecast service providers for the provision of forecasts respecting the Facility. In such event, Buyer shall provide Seller reasonable advance written notice thereof with the date of commencement of such service; provided, if requested by Seller, such solar forecaster selected by Buyer shall execute a confidentiality agreement in form and substance reasonably satisfactory to Seller.

(b) Forecast Procedures. Seller shall, at its sole cost, and at all times during the Term:

(i) Provide Buyer with information in a manner and time frame that allows Buyer to comply, with the CAISO's forecasting and associated data collection requirements as set forth in the CAISO Tariff (including, as applicable, Appendix Q thereof);

(ii) Provide to Buyer:

(A) Annual Forecast of Buyer's Allocation of Energy Production. By December 1 of each calendar year during the Term, Seller shall provide to Buyer a non-binding forecast of Buyer's Allocation of the hourly Energy production for an average day in each month of the follow calendar year in a form reasonably acceptable to Buyer.

(B) Monthly Forecast of Buyer's Allocation of Energy Production. Ten (10) Business Days before the beginning of Commercial Operation, and thereafter ten (10) Business Days before the beginning of each month during the Delivery Term, Seller shall provide to Buyer a non-binding forecast of Buyer's Allocation of the hourly Energy production for each day of the following month in a form reasonably acceptable to Buyer.

(C) Daily Forecast of Buyer's Allocation of Energy Production. During the Delivery Term, Seller shall provide to Buyer a day-ahead forecast of Buyer's Allocation of hourly Energy production for each day no later than as required by WECC, which at a minimum shall be no more than fourteen (14) hours before the beginning of the "Preschedule Day" (as defined by the WECC) for such day. Seller shall notify Buyer of any changes in Buyer's Allocation of hourly Energy production of one (1) MWh or more, whether due to Forced Outage, Force Majeure Event, or other cause within thirty (30) minutes after obtaining knowledge of such event. Such notices shall contain information regarding the beginning date and time of the event resulting in the change in Buyer's Allocation of hourly Energy production, the expected end date and time of such event, and the expected Available Contract Capacity in MW during such event. Seller shall keep Buyer informed of any developments that will affect either the duration of such outage or the availability of the Facility during or after the end of such outage.

(iii) If any Governmental Authority imposes forecasting requirements associated with the Product, Seller shall comply, and provide Buyer with information in a manner and time frame that allows Buyer to comply with such forecasting requirements ((i), (ii) above and this subsection (iii), the "Forecast Procedures").

(c) Each Party shall perform its respective scheduling and forecasting obligations in compliance with all applicable: (i) operating policies, criteria, rules, guidelines, tariffs and protocols of the CAISO, (ii) WECC scheduling practices, and (iii) Prudent Operating Practices. Seller shall assume all liability and be responsible for any and all CAISO Penalties (or other penalties, costs or charges) incurred by Buyer due to Seller's failure to comply with the Forecasting Procedures or Scheduling Procedures or Seller's failure to comply with its obligations set forth in Section 2.9(d). Buyer shall assume all liability and be responsible for any and all CAISO Penalties (or other penalties, costs or charges) incurred by Seller due to Buyer's failure to comply with the Scheduling Procedures. Any invoice submitted by either Buyer or Seller related to CAISO Penalties shall include the related CAISO invoice and a written statement explaining in reasonable detail the calculation of the amount due. Any disputes with respect to such amounts shall be resolved in accordance with Section 8.16.

(d) Outage Notification.

(i) Seller shall comply with the CAISO Tariff regarding notifying CAISO with respect to, and securing any necessary CAISO approvals for, all Facility outages, including Forced Outages and Planned Outages, and Seller shall comply with the CAISO Tariff regarding all CAISO reporting requirements with regard to outages through use of the CAISO OMS (as defined in the CAISO Tariff) electronic-outage reporting system (or a successor reporting system). Seller shall conform the timing and extent of all Planned Outages with the outage schedule provided to CAISO. Seller shall be responsible for securing CAISO approval for

changes in its outage schedules if CAISO disapproves Seller's proposed schedules or if there is any cancellation of previously approved outages. Seller shall promptly notify Buyer of all Forced Outages and Planned Outages and provide Buyer with a copy of any communications with CAISO with respect to such outages.

(ii) No later than (A) thirty (30) days prior to the anticipated Commercial Operation Date, and (B) at least at least sixty (60) days before July 1 of each calendar year throughout the Term, Seller shall submit to Buyer, Seller's schedule of proposed Planned Outages ("Outage Schedule") for the subsequent twelve (12) month period, and Seller shall provide the following information for each proposed Planned Outage:

- (1) Start date and time;
- (2) End date and time;
- (3) Available Capacity of the Facility during the Planned Outage; and
- (4) Purpose for the Planned Outage.

(iii) Seller shall not schedule Planned Outages during the months of June to September, unless (1) such Planned Outage is required to avoid damage to the Facility, (2) such Planned Outage is necessary to maintain equipment warranties and cannot be scheduled outside the months of June through September, (3) such Planned Outage is required in accordance with Prudent Operating Practices, or (4) the Parties agree otherwise in writing.

(iv) Within thirty (30) days after Buyer's receipt of a proposed Outage Schedule, Buyer shall notify Seller in writing of any reasonable request for changes to the Outage Schedule, and Seller shall, consistent with Prudent Operating Practices, use commercially reasonable efforts to accommodate Buyer's requests regarding the timing of any Planned Outage. If a condition occurs at the Facility that causes Seller to revise its Planned Outages, Seller shall provide prompt notice to Buyer, which notice shall be provided within five (5) Business Days of Seller's becoming aware of such condition or revision (including an estimate of the length of such Planned Outage).

## **2.10 Capacity Rights.**

(a) Buyer shall be entitled to Buyer's Allocation of all Capacity Rights associated with the Facility during the Delivery Term. The consideration for all such Capacity Rights is included within the Contract Price.

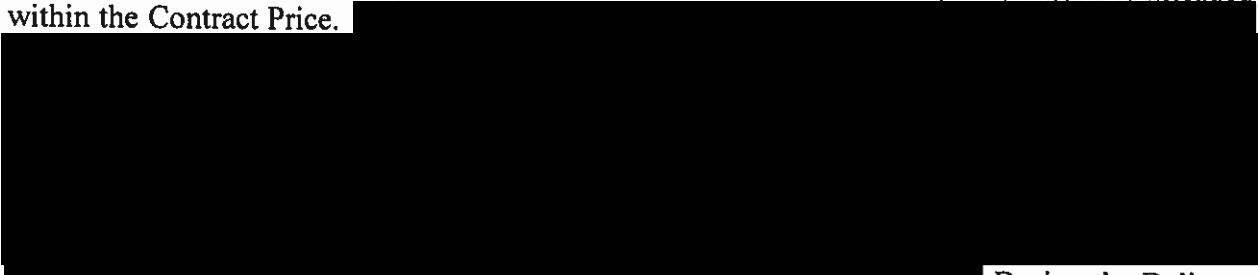
 During the Delivery Term, Seller shall not sell or attempt to sell Buyer's Allocation of the Facility's Capacity Rights to any other Person, and Seller shall not report to any person or entity that Buyer's Allocation of the Facility's Capacity Rights belong to anyone other than Buyer.

(b) At Buyer's request Seller shall: (i) execute such documents and instruments as may be reasonably required to effect recognition and transfer of the NQC associated with the Buyer's Allocation of the Facility's Capacity Rights to Buyer; and (ii) cooperate reasonably with Buyer in order that Buyer may satisfy the Resource Adequacy requirements, if any, including: (A) registering the Facility with the CAISO so that the NQC associated with Buyer's Allocation of the Facility's Capacity Rights are able to be recognized and counted for Resource Adequacy purposes; (B) assisting Buyer in making such annual submissions to the CAISO associated with establishing the correct quantity representing the NQC associated with Buyer's Allocation of the Facility's Capacity Rights; (C) coordinating with Buyer on the submission to the CAISO of the monthly Supply Plan submissions (or corrections), as required by the CAISO Tariff; and (D) providing the CAISO all necessary information for annual and other outage planning.

(c) Seller shall deliver such additional documents, instruments, submissions and information as may be requested by Buyer in connection with Buyer's Allocation of the Facility's Capacity Rights; *provided*, that in responding to any such requests, Seller shall have no obligation to provide any consent, certification, representation, information or other document, or enter into any agreement, that materially adversely affects, or could reasonably be expected to have or result in a material adverse effect on, any of Seller's rights, benefits, risks and/or obligations under this Agreement.

(d) At all times during the Term, Seller shall install such meters and power electronics as are necessary so that Buyer's Allocation of the Facility's Capacity Rights may be delivered to Buyer. For Seller to obtain the Contract Price corresponding to having delivered Buyer's Allocation of the Facility's Capacity Rights to Buyer, Seller shall (i) have obtained FCDS for Facility Capacity sufficient for Buyer's Allocation of the Facility's Capacity Rights to equal the Contract Capacity, and (ii) have delivered Capacity Rights to Buyer for the corresponding Showing Month of the Delivery Term. The total amount of Capacity Rights identified and confirmed for each day of such Showing Month shall equal the then applicable NQC of the Facility. Seller shall deliver the Capacity Rights by submitting the Facility and its NQC to the CAISO in Seller's Supply Plan. The Capacity Rights shall be deemed delivered and received when the CIRA Tool shows the Supply Plan accepted for the NQC from the Facility by CAISO or Seller complies with Buyer's instruction to withhold all or part of the NQC from Seller's Supply Plan for any Showing Month during the Delivery Term but Seller otherwise delivers the amount of NQC that Buyer does not direct Seller to withhold. Seller has failed to deliver the Capacity Rights if (i) Buyer has elected to submit the NQC from the Facility in its Resource Adequacy Plan and such submission is accepted by the CPUC and the CAISO but the Supply Plan and Resource Adequacy Plan are not matched in the CIRA Tool and are rejected by CAISO, or (ii) Seller fails to submit in its Supply Plan the volume of NQC for any Showing Month in such amount as instructed by Buyer for the applicable Showing Month. Seller will not have failed to deliver the Capacity Rights if Buyer fails to submit or chooses not to submit the Facility and the NQC in its Resource Adequacy Plan with the CPUC or CAISO

(e) Notwithstanding anything herein to the contrary, Seller shall have no obligation to deliver Capacity Rights pursuant to this Section 2.10, and Seller shall not be subject to any Contract Price reduction pursuant to Section 2.10(a), in the event of changes to Applicable Law that result in Buyer no longer being subject to RA procurement requirements under the CAISO Tariff and Applicable Laws.

### **2.11 Sales for Resale.**

All Energy delivered to Buyer hereunder shall be sales for resale, with Buyer reselling such Energy. Buyer shall provide Seller with any documentation reasonably requested by Seller to evidence that the deliveries of Energy hereunder are sales for resale.

## **ARTICLE 3 TERM; TERMINATION; DEFAULTS**

### **3.1 Term.**

The "Term" of this Agreement shall commence on the Effective Date and continue until 23:59 pm PPT on the date that is fifteen (15) years after the first day of the Delivery Term, unless sooner terminated in accordance with the terms hereof. The Term may be renewed or extended by mutual consent of the Parties, upon terms and conditions and for a price upon which the Parties mutually agree in connection with such extension or renewal.

### **3.2 Regulatory Approvals; Certifications; Qualifications.**

(a) Except as specifically provided for herein, each Party shall maintain (or obtain from time to time as required, including through renewal, as applicable) all regulatory authorizations necessary for it to legally perform its obligations under this Agreement.

(b) Seller shall file an application for CEC pre-Certification and Verification for the Facility within sixty (60) days following the Effective Date. Seller shall, at its sole expense, take all steps necessary to ensure that during the Delivery Term: (i) the Facility qualifies and is certified by the CEC as an Eligible Renewable Energy Resource, and in that regard, Seller shall submit an application to the CEC for final CEC Certification and Verification within ten (10) Business Days after the Commercial Operation Date; (ii) the Renewable Energy Credits transferred to Buyer conform to the definition and attributes required for compliance with Portfolio Content Category 1 and meet the criteria of California Public Utilities Code Section 399.16(b)(1), and as such, Seller shall ensure that in all cases the Renewable Energy Credits and Energy from the Facility are bundled according to the applicable CEC RPS Eligibility Guidebook; and (iii) the Facility is maintained and operated in a manner so as to preserve such certification and qualification.

(c) Seller shall, at its sole expense, make any filings and submit any reports necessary for the Facility to maintain and comply with CEC, ERR and California Renewables Portfolio Standard certifications and qualifications during the Delivery Term and shall promptly provide Buyer with copies of any such filings or reports. Buyer shall cooperate with Seller by providing promptly to Seller such data and information necessary, if any, in order for Seller to prepare and submit such filings and reports. In the event Seller fails to make such filings or submit such reports necessary to maintain such CEC, ERR and California Renewables Portfolio Standard certifications and qualifications (and such failure is not caused by Buyer's actions or inactions), Buyer, on prior notice to Seller and at Seller's expense, may take any and all actions deemed necessary by Buyer, on behalf of Seller and as Seller's agent, to maintain such CEC, ERR and



California Renewables Portfolio Standard certifications and qualifications, including executing all necessary California regulatory agency documentation in order to accomplish the foregoing.

(d) To the extent the Facility is eligible to participate in the EIRP prior to the Commercial Operation Date, Seller shall, at its sole cost, promptly undertake such actions as may be necessary to ensure the Facility participates in EIRP at the earliest date possible. Seller shall provide Buyer immediate oral notice of its receipt from CAISO of any notice or certification from CAISO regarding the Facility's participation in EIRP and shall provide Buyer with a written copy of the notice from CAISO certifying the Facility as eligible to participate in the EIRP within one (1) Business Day of Seller's receipt of such notice of EIRP certification. At all times following EIRP certification, Seller shall, at its sole cost, participate in and comply with EIRP as directed by Buyer and shall comply with all additional protocols issued by the CAISO relating to EIRP resources during all hours of the Delivery Term. Seller as Scheduling Coordinator (or Seller's SC) shall facilitate communication between Seller and CAISO and provide other administrative materials to CAISO as necessary to assist Seller's participation in and compliance with EIRP and any additional protocols. Seller shall, at its own expense, comply with, and satisfy the certification requirements of EIRP.

(e) Throughout the Term, Seller shall, at its sole cost, to the extent required by NERC, WECC or FERC, cause the Facility Operator to register with NERC as the Generator Operator of the Facility and in which case Seller shall: (i) cause the Facility Operator to be responsible for complying with all NERC Reliability Standards applicable to a Generator Operator; and, (ii) be liable for all penalties assessed by NERC, FERC or WECC for violations of the NERC Reliability Standards applicable to a Generator Operator.

(f) Notwithstanding any provision of this Agreement, Seller acknowledges that Buyer has no obligation to register with NERC as a Generator Operator or any other applicable NERC registration category with respect to the Facility, as a result of this Agreement, or to comply with any NERC Reliability Standards or requirements thereunder applicable to the Facility.

### **3.3 [Reserved].**

### **3.4 Defaults; Remedies; Termination Payment.**

(a) Default. Each of the following shall constitute an "Event of Default" hereunder:

(i) A Party has made a representation or warranty herein that is false or incorrect in a material respect that has a material adverse effect on the other Party (the non-defaulting Party), and the non-defaulting Party provides to other Party notice of the same, and: (A) such misrepresentation or breach of warranty is not remedied within twenty (20) Business Days after notice is received by the defaulting Party; or (B) if such inaccuracy is not capable of being remedied, but the non-defaulting Party's damages resulting from such inaccuracy can be reasonably ascertained, then if payment of such damages is not made within ten (10) Business Days after a notice of such damages is provided by the non-defaulting Party to the defaulting Party;

(ii) A Party fails to pay any undisputed amount due hereunder, where such failure is not cured within ten (10) Days after written notice from the other Party of such failure to pay;

(iii) A Party has (a) filed or otherwise commenced a voluntary case under any bankruptcy law, applied for or consented to the appointment of, or the taking of possession by, a receiver, trustee, assignee, custodian or liquidator of all or a substantial part of its assets, (b) failed, or admitted in writing its inability generally, to pay its debts as such debts become due, (c) made a general assignment for the benefit of creditors, which excludes collateral assignment to Lenders pursuant to Section 8.2(b)(i), (d) been adjudicated bankrupt or has filed a petition or an answer seeking an arrangement with creditors, (e) taken advantage of any insolvency law or shall have submitted an answer admitting the material allegations of a petition in bankruptcy or insolvency proceeding, (f) become subject to an order, judgment or decree for relief, entered in an involuntary case, without the application, approval or consent of such Party by any court of competent jurisdiction appointing a receiver, trustee, assignee, custodian or liquidator, for a substantial part of any of its assets and such order, judgment or decree shall continue unstayed and in effect for any period of sixty (60) consecutive Days, (g) failed to remove or stay an involuntary petition in bankruptcy filed against it within sixty (60) Days of the filing thereof, or (h) become subject to an order for relief under the provisions of the United States Bankruptcy Act, 11 U.S.C. § 301;

(iv) Seller fails to maintain Site Control, if such default has not been cured by Seller within thirty (30) Days after receiving written notice from Buyer; provided, however, that, in the case of any such default that is not reasonably capable of being cured within the thirty (30) Day cure period, Seller shall have up to an additional sixty (60) Days if it commences to cure the default within such initial thirty (30) Day cure period and it diligently and continuously pursues such cure;

(v) Seller fails to post or maintain Development Security or Operating Security in compliance with Section 3.6 and such default is not cured within ten (10) Business Days after notice from Buyer;

(vi) Seller fails to achieve Commercial Operation of Facility Capacity sufficient for Buyer's Allocation of Capacity to equal at least ninety-five (95%) of the Contract Capacity on or before the date that is one hundred and twenty (120) Days after the Guaranteed Commercial Operation Date, after giving effect to all Permitted Extensions, and such failure is not cured within five (5) Business Days after notice;

(vii) Seller fails to obtain CEC Certification and Verification within ninety (90) Days of the Commercial Operation Date or Seller fails to maintain such status thereafter through the end of the Term, or the Facility fails to qualify as an ERR and any Energy from the Facility sold to Buyer fails to qualify as eligible renewable energy for purposes of the California Renewables Portfolio Standard, and such failure is not cured within ten (10) Business Days after notice;

(viii) Except as otherwise provided herein, during the Term, Seller assigns, transfers, conveys, encumbers, sells, or otherwise disposes of all or any portion of the Product

that is to be sold and delivered to Buyer under this Agreement to any person other than Buyer, or Seller delivers, or attempts to schedule or deliver, energy to the Delivery Point to satisfy its obligations under this Agreement that was not generated by or attributable to the Facility;

(ix) Buyer fails to meet its obligations under Section 5.4 hereof with respect to the Buyer Financial Security, if applicable;

(x) Seller fails to deliver Buyer's Allocation of Energy together with Excused Energy during a Performance Period in a quantity greater than seventy percent (70%) of the total Minimum Annual Energy Production corresponding to the two (2) Contract Years of the Performance Period; provided, however, that no Event of Default shall occur if, (i) within ten (10) Business Days of receipt of Buyer's notice of default hereunder, Seller proposes a reasonably-detailed remedial action plan to cure such default, and (ii) Seller delivers Buyer's Allocation of Energy together with Excused Energy in a quantity greater than seventy percent (70%) of the total Minimum Annual Energy Production corresponding to the two (2) Contract Years of the next Performance Period;

(xi) Seller has not sold or delivered Buyer's Allocation of Energy from the Facility to Buyer for a period of twelve (12) consecutive months after the Commercial Operation Date, except due to during the pendency of, and to the extent required by (A) a Force Majeure Event, (B) a Buyer Curtailment Order, (C) a Curtailment Period, provided such Curtailment Period is not attributable to Seller's breach of its obligations under this Agreement or the Interconnection Agreements, or (D) a period of Seller suspension due to a Buyer Event of Default pursuant to Section 3.4(b)(ii); or

(xii) Any other default in performance or observance by a Party of any agreement, undertaking, covenant or other obligation contained in this Agreement that has a material adverse effect on the other Party if such default has not been cured by the defaulting Party within thirty (30) Days after receiving written notice from the non-defaulting Party setting forth, in reasonable detail, the nature of such default and its impact on the non-defaulting Party; provided, however, that, in the case of any such default that is not reasonably capable of being cured within the thirty (30) Day cure period, the defaulting Party shall have up to an additional sixty (60) Days if it commences to cure the default within such initial thirty (30) Day cure period and it diligently and continuously pursues such cure.

(b) Remedies. Upon the occurrence of, and during the continuation of, an Event of Default by a Party, the non-defaulting Party shall have the right but not the obligation to:

(i) Subject to Section 8.8, pursue all remedies given under this Agreement or now or hereafter existing at law, in equity or otherwise;

(ii) Suspend performance of its obligations and duties hereunder immediately upon delivering written notice to the defaulting Party of its intent to exercise its suspension rights; and

(iii) Terminate this Agreement by notice to the other Party, designating a Day no less than thirty (30) Days after such notice, as an early termination date (the "Early

Termination Date”) to accelerate all amounts then owing between the Parties and to liquidate and terminate this Agreement.

(c) Termination Payment.

(i) As soon as practicable after the declaration of an Early Termination Date, notice shall be given by the non-defaulting Party to the defaulting Party of the amount of the Termination Payment, which shall in no event exceed [REDACTED]. The non-defaulting Party shall calculate the Termination Payment in a commercially reasonable manner as of the Early Termination Date. The notice shall include a written statement explaining in reasonable detail the calculation of such amount. The Termination Payment, if any, shall be made by the Party owing the Termination Payment within five (5) Business Days after such notice is effective and shall bear interest at the Prime Rate from the due date until paid.

(ii) “Termination Payment” means an amount equal to the sum of all Losses (if any) and all Costs (if any) incurred by the non-defaulting Party as a result of the termination of this Agreement, plus all amounts then currently due from the defaulting Party to the non-defaulting Party under this Agreement, minus all amounts due to the defaulting Party under this Agreement, so that all such amounts shall be netted to a single liquidated amount payable by the defaulting Party to the non-defaulting Party.

(iii) If the defaulting Party disputes the non-defaulting Party’s calculation of the Termination Payment, in whole or in part, the defaulting party shall, within ten (10) Business Days of receipt of the non-defaulting Party’s calculation of the Termination Payment, provide to the non-defaulting Party a detailed written explanation of the basis for such dispute. Disputes regarding the Termination Payment shall be resolved in accordance with Section 8.16. Notwithstanding any provision of this Agreement, Buyer and Seller shall each have a duty to mitigate damages pursuant to this Agreement, and each shall use reasonable efforts to minimize any damages it may incur as a result of the other Party’s non-performance of this Agreement, including with respect to termination of this Agreement.

**3.5 *Specific Performance; Injunctive Relief.***

Each Party shall be entitled to seek a decree compelling specific performance with respect to, and shall be entitled, without the necessity of filing any bond, to seek the restraint by injunction of, any actual or threatened breach of any material obligation of the other Party under this Agreement. The Parties in any action for specific performance or restraint by injunction agree that they shall each request that all expenses incurred in such proceeding, including reasonable counsel fees, be apportioned in the final decision based upon the respective merits of the positions of the Parties.

**3.6 *Seller’s Financial Support Obligations.***

(a) Development Security. Seller shall provide to Buyer as security for the performance of Seller’s obligations hereunder, a combination of (a) a Letter of Credit from a Qualified Institution reasonably acceptable to Buyer, (b) a cash deposit, or (c) Corporate Guaranty, collectively in an amount equal to [REDACTED] (the

“Development Security”). Seller shall post the Development Security within ten (10) Business Days after the Effective Date. Buyer shall have the right to draw upon the Development Security, at Buyer’s sole discretion, in the event Seller fails to make any payments due and owing under this Agreement or to reimbursement Buyer for costs or damages, including Daily Delay Damages and Contract Capacity Damages, that Buyer has incurred as a result of Seller’s failure to perform its obligations under this Agreement. Within five (5) Business Days following any draw by Buyer on the Development Security, Seller shall replenish the amount drawn such that the Development Security is restored to the full amount. Buyer shall release the Development Security, less amounts drawn, if any, to Seller upon the earlier of (i) the termination of this Agreement in accordance with its terms; or (ii) the tenth (10th) Business Day after Seller posts the Operating Security pursuant to Section 3.6(b). Upon the consent of Buyer, with respect to cash held as Development Security, Seller may elect to apply and maintain the unused portion of the Development Security, if any, as a portion of Operating Security pursuant to Section 3.6(b).

(b) Operating Security. As a condition of Buyer’s continuing obligation under this Agreement, Seller shall provide to Buyer as security for the performance of Seller’s obligations during the Delivery Term, a combination of (a) a Letter of Credit from a Qualified Institution reasonably acceptable to Buyer, or (b) a cash deposit, or (c) Corporate Guaranty, collectively in an amount equal to [REDACTED] (the “Operating Security”). Seller shall post the Operating Security on or prior to the Commercial Operation Date and maintain the Operating Security until the end of the Term. Buyer shall have the right to draw upon the Operating Security, at Buyer’s sole discretion, in the event Seller fails to make any payments owing under this Agreement or to reimburse Buyer for costs or damages that Buyer has incurred as a result of Seller’s failure to perform under this Agreement. Within five (5) Business Days following any draw by Buyer on the Operating Security, Seller shall replenish the amount drawn such that the Operating Security is restored to the full amount; *provided* that in no event shall the maximum recovery by Buyer under the Operating Security exceed [REDACTED]. Buyer shall release the Operating Security, less amounts drawn, if any, to Seller upon the earlier of (i) termination of this Agreement in accordance with its terms; and (ii) on the tenth (10th) Business Day after the expiration of the Term.

(c) With respect to any Letter of Credit posted hereunder, on or before the date that is thirty (30) days prior to the expiration date of any Letter of Credit, Seller shall cause the Letter of Credit to be renewed or replaced with another Letter of Credit in an equal amount. Buyer shall have the right to draw on a Letter of Credit, at Buyer’s sole discretion if (A) such Letter of Credit has not been renewed or replaced at least thirty (30) days prior to the date of its expiration or (B) the issuer is no longer a Qualified Institution and Seller has not caused a replacement Letter of Credit to be issued for the benefit of Buyer within ten (10) Business Days of such issuer no longer qualifying as a Qualified Institution; provided that if Buyer draws upon any Letter of Credit for the foregoing reasons and Seller subsequently posts a replacement Letter of Credit or extends or renews a Letter of Credit (in the case of (A) above), the proceeds of Buyer’s drawing shall be returned to Seller.

(d) With respect to any Corporate Guaranty posted hereunder, on or before the date that is five (5) Business Days following a downgrade in Credit Rating that results in the Seller-

affiliated entity that has posted a Corporate Guaranty no longer qualifying as a Qualifying Guarantor, Seller shall cause the Corporate Guaranty to be replaced with a combination of (a) a Letter of Credit from a Qualified Institution reasonably acceptable to Buyer, or (b) a cash deposit in an equal amount sufficient to maintain Development Security or Operating Security in compliance with Section 3.6.

#### **ARTICLE 4 BILLING AND PAYMENT; METERING AND MEASUREMENT**

##### **4.1 *Billing; Payment.***

(a) Billing and payment for Product sold to and purchased by Buyer under this Agreement and any other amounts due and payable hereunder, including Buyer's payments for Available Energy, if any, shall be as follows:

(i) Commencing on the Effective Date and continuing throughout the Term, Seller shall, consistent with Section 4.2, calculate: (A) the amount of Buyer's Allocation of Energy delivered at the Delivery Point from recordings produced by the Meter(s) for the Facility on or near the last Day of each calendar month through last Day of the final Contract Year; and (B) the amount of Available Energy, if any, for each calendar month through the last Day of the final Contract Year.

(ii) Seller shall use commercially reasonable efforts to deliver to Buyer, not later than the twentieth (20<sup>th</sup>) Day of each calendar month during the Term and for the first calendar month following the expiration thereof, an invoice showing (A) the amount of Buyer's Allocation of Energy delivered by Seller at the Delivery Point (which deliveries shall be adjusted to reflect Electrical Losses to the Delivery Point in accordance with Section 4.2(a)) during the preceding calendar month of the Term, and Seller's computation of the amount due Seller in respect thereof; (B) the amount, if any, of Available Energy during the preceding calendar month of the Delivery Term, and Seller's computation of the amount due Seller in respect thereof; and (C) any other amounts owed by one Party to the other Party pursuant to this Agreement; provided, however, that prior to the beginning of the Delivery Term, Seller's invoices shall include the CAISO Settlement Price for Buyer's Allocation of delivered Energy and Seller's invoices shall not include Available Energy amounts. Seller shall deliver an invoice to Buyer each month during the Term; provided that prior to the Delivery Term, Seller shall only delivery an invoice to Seller for months in which an Energy delivery has occurred. Buyer Seller shall cooperate reasonably with any Buyer request to modify the format, or level of detail, of Seller invoices pursuant to this Agreement.

(iii) Buyer shall pay to Seller the undisputed amount of each invoice within thirty (30) Days after receipt of each invoice (unless such Day is not a Business Day, in which case such payment shall be due on the next succeeding Business Day). To the extent Seller owes Buyer any amounts hereunder, Buyer may set-off such amounts from Buyer's payments to Seller. Buyer shall make payment by wire transfer of immediately available funds to an account specified in writing by Seller or by any other means agreed to by the Parties in writing from time to time.

(b) Except as provided in Section 4.1(e), within one (1) year after receipt of any invoice, either Party may provide written notice to the other Party of any alleged error therein, and the Parties shall meet, by telephone conference call or otherwise, within ten (10) Business Days of the other Party's receipt of such notice, for the purpose of attempting to resolve the dispute. If the Parties are unable to resolve the dispute within thirty (30) Days after such initial meeting, then either Party may proceed to seek any remedy that may be available to such Party at law or in equity.

(c) Except as otherwise provided in this Agreement, all payments hereunder shall be made without set-off or deduction. Any payment not made by the date required by this Agreement shall bear interest from the date on which such payment was required to have been made through and including the date such payment is actually received at an annual rate equal to the Prime Rate then in effect plus two percent (2%), but in no event shall such interest exceed the maximum interest rate permitted by Applicable Law ("Late Payment Rate"). If, as a result of a dispute settled in favor of Buyer, a refund is owed to Buyer, then the amount of the overpayment shall bear interest from the date on which such payment was made by Buyer through and including the date that the overpayment is refunded by Seller at an annual rate equal to the Late Payment Rate.

(d) Statements or invoices shall be sent to Buyer by mail, facsimile, or E-mail to:

Valley Clean Energy Alliance  
604 2nd Street,  
Davis, California 95616  
Attn: Director, Finance and Operations  
Telephone: 530-446-2752  
Facsimile:  
E-mail: [Alisa.Lembke@valleycleanenergy.org](mailto:Alisa.Lembke@valleycleanenergy.org)

Statements or invoices shall be sent to Seller by mail or facsimile to:

Aquamarine Westside, LLC  
C/O CIM Group, LLC  
4700 Wilshire Blvd  
Los Angeles, CA 90010  
Attn: Alex Martinez  
Telephone: [#]  
Facsimile: [#]  
E-mail: [address]

with a CC to:

Aquamarine Westside, LLC  
C/O  
Address:  
Attn:  
Telephone: [#]

Facsimile: [#]  
E-mail: [address]

Either Party may change the address or facsimile number by providing written notice to the other Party.

(e) If Seller or Buyer determines that a calculation of delivered Product or CAISO Penalties is incorrect as a result of inaccurate Meters, the correction of data by the CAISO in MRI-S, or a recalculation of CAISO Penalties or other amounts owing between the Parties, Seller or Buyer, as the case may be, shall promptly re-compute the delivered Product, CAISO Penalties, or other amounts for the period of the inaccuracy based upon an adjustment of inaccurate Meter readings, correction of data or recalculation of CAISO Penalties in accordance with the CAISO Tariff and any payment affected by the adjustment or correction. Any amount due from Buyer to Seller, or Seller to Buyer, as the case may be, will be made as an adjustment to the next monthly payment statement that is calculated after Seller's or Buyer's re-computation using corrected measurements. If the re-computation results in a net amount owed to Buyer after applying any amounts owing to Seller as shown on the next monthly payment statement, any such amount owing to Buyer shall, at Buyer's discretion, be netted against amounts owed to Seller in any subsequent monthly payment invoice or be separately invoiced to Seller, in which case Seller must pay the amount owing to Buyer within twenty (20) days after receipt of that invoice. Buyer or Seller may make payment adjustments arising from a recalculation of CAISO Penalties or as a result of inaccurate Meters after the end of a Contract Year. Adjustment payments for Meter inaccuracy will not bear interest.

#### **4.2 Metering Equipment.**

(a) During the Delivery Term, Seller shall: (i) provide and maintain, at its cost, all metering and recording equipment necessary to meet all applicable WREGIS, CEC and CPUC requirements to permit an accurate determination of the quantities of Green Attributes generated by the Facility; (ii) provide and maintain, at its cost, Meter(s) and associated measuring and recording equipment necessary to meet all applicable CAISO requirements to permit an accurate determination of the quantities of Energy delivered to the Delivery Point under this Agreement; (iii) measure all deliveries of Energy through Seller's CAISO revenue Meter(s) assigned to the Facility on the low or high side (at Seller's discretion) of the Facility's final step up transformer located closest to the Delivery Point; (iv) utilize Meter(s) at the Facility on both the low and/or high side (at Seller's discretion) of the final step up transformer and/or at the POI to account for Electrical Losses to the Delivery Point; (v) ensure that Meter(s), and any Back Up Meter(s), shall be adjusted to reflect Seller's deliveries of Energy at the Delivery Point using a formula reasonably acceptable to Buyer to account for Electrical Losses associated with transmission of Energy to the Delivery Point; and, (vi) exercise reasonable care in the maintenance and operation of any such Meter(s) and Back Up Meter(s) so as to assure to the maximum extent reasonably practicable an accurate determination of the quantities of Energy delivered to Buyer at the Delivery Point under this Agreement. A metering diagram is attached as **Exhibit C**.

(b) During the Term, all Energy from the Facility must be delivered through Meter(s) and Back-Up Meter(s), as applicable, and must be measured by the Meter(s) or Back-Up



Meter(s) to be eligible for payment under this Agreement. Seller shall bear all costs relating to Meter(s) installed to measure the delivery of Energy, except for Back-Up Meter(s) installed at the direction of Buyer, which costs to purchase, install and maintain such Back-Up Meter(s) installed at the direction of Buyer shall be borne by Buyer. Seller hereby agrees to obtain and provide all Meter data, including all inspection, testing and calibration data and reports, to Buyer in a form reasonably acceptable to Buyer, and consents to Buyer obtaining from the CAISO the CAISO meter data applicable to the Facility and all related inspection, testing and calibration data and reports. Seller shall grant Buyer the right to access and retrieve the meter reads from the CAISO Market Results Interface – Settlements (MRI-S) application and/or directly from the Meter(s) at the Site; provided, any such access to the Site be in a manner consistent with the access provisions of Section 5.6. If the CAISO adjusts any CAISO Meter data related to a specific time period, Seller agrees that it shall, pursuant to Section 4.1(e), submit revised monthly invoices related to such time period in order to reconcile past invoices to conform fully with such CAISO Meter data adjustments. Seller shall submit any such revised invoice no later than thirty (30) days from the date on which it receives from the CAISO such binding adjustment to the Meter data.

(c) Seller shall test and calibrate the Meter(s), as necessary, but in no event shall the period between testing and calibration dates be greater than twelve (12) months. Seller shall bear the cost for any Meter check or recertification of the Meter(s); provided, Buyer shall reimburse Seller the costs associated with recertification of a Back-up Meter installed at the direction of Buyer. Seller shall replace Meter and Back-Up Meter batteries at least once every thirty-six (36) months, or such shorter period as may be recommended by the Meter or Back-Up Meter manufacturer. Notwithstanding the foregoing, if a Meter or Back-Up Meter battery fails, Seller shall replace such battery within three (3) days after becoming aware of its failure. Seller shall use certified test and calibration technicians to perform any work associated with Meter(s) and Back-Up Meter(s), and Seller shall provide Buyer certified results of tests and calibrations within thirty (30) days after completion.

(d) Buyer is permitted, but not obligated, to request, at Buyer's sole cost and expense, that Seller furnish and install one or more Back-Up Meters at mutually agreed locations. All such Back-Up Meters shall be CAISO approved and the readings from each such Back-Up Meter shall be adjusted to reflect Seller's Energy deliveries at the Delivery Point, taking into account Electrical Losses.

(e) All of the Meters and Back-Up Meters shall be locked or sealed, and the lock or seal shall be broken only for purposes of testing, calibration, or adjustment. If any Meter or Back-Up Meter is found to be defective or inaccurate, it shall be adjusted, repaired, replaced, and/or recalibrated as near as practicable to a condition of zero error by the Seller at the expense of the Party owning such defective or inaccurate device. Each Party grants the other Party the right to request additional tests of such Party's Meter(s) or Back-Up Meter(s), as applicable, with reasonable prior notice and at reasonable time in order to verify the accuracy of such Meter(s) or Back-Up Meter(s) and the Party owning such Meter or Back-Up Meter shall perform such additional tests; provided, such inspections and verifications shall be at the requesting Party's sole expense and shall not occur more than two (2) times each Contract Year for each Meter or Back-Up Meter during the Term; provided that if a test of a Meter or Back-Up Meter determines that the Meter or Back-Up Meter is inaccurate by more than one half percent (0.5%), the Party

owning the Meter or Back-Up Meter shall pay for such test and such test shall not count towards the two test per Contract Year for each Meter or Back-Up Meter limit described above.

(f) If a Meter or Back-Up Meter fails to register, or if the measurement made by a Meter or Back-Up Meter is found upon testing to be inaccurate by more than one half percent (0.5%), an adjustment shall be made correcting all measurements by the inaccurate or defective Meter or Back-Up Meter for both the amount of the inaccuracy and the period of the inaccuracy, in the following manner:

(i) In the event that a Meter is found to be defective or inaccurate, the Parties shall use readings from a Back-Up Meter, if installed, to determine the amount of such inaccuracy; provided, however, that such Back-Up Meter has been tested and maintained in accordance with the provisions of this Agreement. If there is no Back-Up Meter, or such Back-Up Meter is also found to be inaccurate by more than one half percent (0.5%), the Parties shall estimate the amount of the necessary adjustment on the basis of deliveries of Energy from the Facility to the Delivery Point during periods of similar operating conditions when the Meter was registering accurately. The adjustment shall be made for the period during which inaccurate measurements were made.

(ii) If the Parties cannot agree on the actual period during which the inaccurate measurements were made, the period during which the measurements are to be adjusted shall be the shortest of (A) the last one-half of the period from the last previous test of the Meter to the test that found the Meter to be defective or inaccurate, (B) the last one-half of the period from the last previous test of the Back-Up Meter to the test that found the Back-Up Meter to be defective or inaccurate, or (C) the one hundred eighty (180) days.

(g) Notwithstanding any provisions set forth in this Section 4.2, to the extent there is an inconsistency between this Agreement and the provisions of the CAISO Tariff or Metering Services Agreement, the CAISO Tariff or Metering Services Agreement shall control.

#### **4.3 *Maintenance; Records.***

During the Term, Seller shall provide Buyer reports indicating the amount of Buyer's Allocation of Energy delivered to Buyer at the Delivery Point from recordings produced by the Meter(s) for the Facility. Seller shall provide reports on a frequency, and in a format, as reasonably requested by Buyer. Buyer shall have the right to be present whenever Seller reads, cleans, changes, repairs, inspects, tests, calibrates, or adjusts the Meter(s), Back-Up Meter(s), or any of Seller's equipment used in measuring or checking the measurement of the amount of Energy delivered to the Delivery Point during the Term; provided, any such access to the Site be in a manner consistent with the access provisions of Section 5.6. Seller shall give at least two (2) Business Days' notice to Buyer in advance of taking any such actions. The records from the measuring equipment shall remain the property of Seller, but, upon request, Seller shall submit to Buyer its records and charts, together with calculations therefrom, for inspection, verification and copying, subject to return within ten (10) Days after receipt thereof. Seller agrees to retain such records for a period no less than two (2) years.

#### **4.4 *Electronic Communications.***

During the Delivery Term, Seller shall provide Buyer, at Seller's sole expense, the instantaneous net MW flow updated every minute via file transfer protocol which represents the quasi real time electronic Meter data from the Facility. During the Delivery Term, Seller shall use commercially reasonable efforts to transmit to Buyer, on a real time basis, any other operational data from the Facility that Seller receives or possesses. During the Delivery Term, Seller, at its own expense, shall: (a) install and maintain at least one (1) stand-alone meteorological station (the "Meteorological Station") at the Site to monitor and report meteorological data; (b) install and maintain additional Meteorological Stations at the Facility, if any, required pursuant to the CAISO Tariff; (c) provide meteorological data to Buyer on the same basis on which Seller receives the data within its SCADA System (e.g., if Seller receives the data in five (5) minute intervals, Buyer shall also receive the data in five (5) minute intervals); and (d) install such equipment for the communication of such meteorological data to Buyer as required by the CAISO Tariff (Appendix Q) or as the Parties may agree.

### **ARTICLE 5 REPRESENTATIONS, WARRANTIES AND COVENANTS**

#### **5.1 *Seller's Representations and Warranties.***

(a) Seller represents and warrants as follows:

(i) Seller is a limited liability company, duly organized, validly existing, and in good standing under the laws of the State of Delaware, and authorized to conduct business in the State of California;

(ii) Seller has the power and authority to enter into and perform this Agreement and is not prohibited from entering into this Agreement or discharging and performing all covenants and obligations on its part to be performed under and pursuant to this Agreement;

(iii) Seller has taken all action required by Applicable Law and its documents of formation in order to approve, execute and deliver this Agreement;

(iv) The execution and delivery of this Agreement, the consummation of the transactions contemplated herein, and the fulfillment of and compliance by Seller with the provisions of this Agreement will not conflict with or constitute a breach of, or a default under, any provisions of any law, rule or regulation, any order, judgment, writ, injunction, decree, determination, award or other instrument or legal requirement of any court or other agency of government, the documents of formation of Seller, or any contractual limitation, restriction or outstanding trust indenture, deed of trust, mortgage, loan agreement, lease, other evidence of indebtedness or any other agreement or instrument to which Seller is a party or by which it or any of its property is bound and will not result in a breach of or a default under any of the foregoing;

(v) Seller has taken all such action as may be necessary or advisable and proper to authorize this Agreement, the execution and delivery hereof, and the consummation of transactions contemplated hereby;

(vi) There are no bankruptcy, insolvency, or receiverships pending or being contemplated by Seller, or to its knowledge threatened against Seller;

(vii) There are no actions or proceedings pending or, to Seller's knowledge, threatened, and there are no judgments, rulings or orders issued by any court or other Governmental Authority, that would materially adversely affect Seller's ability to perform its obligations under this Agreement;

(viii) This Agreement is a legal, valid and binding obligation of Seller enforceable in accordance with its terms, except as limited by laws of general applicability limiting the enforcement of creditor's rights or by the exercise of judicial discretion in accordance with general principles of equity; and

(ix) Seller has procured or will procure prior to the commencement of the Delivery Term all real property rights required for the operation of the Facility at the Site and the performance of any obligations of Seller hereunder, and the terms of each are for periods of no less than the Term.

## **5.2 Buyer's Representations and Warranties.**

(a) Buyer represents and warrants as follows:

(i) Buyer is a Joint Powers Authority in accordance with the Joint Powers Act of the State of California (Government Code Section 6500 *et seq.*) and as such is duly organized, validly existing and in good standing under the laws of the State of California and authorized to conduct business in California;

(ii) Buyer has the power and authority to enter into and perform this Agreement and is not prohibited from entering into this Agreement or discharging and performing all covenants and obligations on its part to be performed under and pursuant to this Agreement;

(iii) Buyer has taken all action required by Applicable Law in order to approve, execute and deliver this Agreement;

(iv) The execution and delivery of this Agreement, the consummation of the transactions contemplated herein and the fulfillment of and compliance by Buyer with the provisions of this Agreement will not conflict with or constitute a breach of or a default under or require any consent, license or approval that has not been obtained pursuant to any of the terms, conditions or provisions of any law, rule or regulation, any order, judgment, writ, injunction, decree, determination, award or other instrument or legal requirement of any court or other agency of government, the documents of formation of Buyer or any contractual limitation, restriction or outstanding trust indenture, deed of trust, mortgage, loan agreement, lease, other evidence of indebtedness or any other agreement or instrument to which Buyer is a party or by

which it or any of its property is bound and will not result in a breach of or a default under any of the foregoing;

(v) Buyer has taken all such action as may be necessary or advisable and proper to authorize this Agreement, the execution and delivery hereof, and the consummation of transactions contemplated hereby;

(vi) There are no bankruptcy, insolvency, reorganization or receiverships pending or being contemplated by Buyer, or to its knowledge threatened against Buyer;

(vii) There are no actions or proceedings pending or, to Buyer's knowledge, threatened, and there are no judgments, rulings or orders issued by any court or other governmental body that would materially adversely affect Buyer's ability to perform its obligations under this Agreement; and

(viii) This Agreement is a legal, valid and binding obligation of Buyer enforceable in accordance with its terms, except as limited by laws of general applicability limiting the enforcement of creditor's rights or by the exercise of judicial discretion in accordance with general principles of equity.

### **5.3 *Seller's Covenants.***

(a) Seller covenants that:

(i) At all times during the Term, the Facility shall be operated and maintained in accordance with this Agreement, Prudent Operating Practices, and Applicable Laws;

(ii) From the Effective Date through the expiration or termination of this Agreement, Seller shall comply with this Agreement and the CAISO Tariff;

(iii) Except for assignments authorized in accordance with Section 8.2, Seller shall at all times own and operate the Facility;

(iv) Seller shall obtain, maintain, and remain in compliance with all Permits, Interconnection Agreements, and transmission and distribution rights necessary to operate the Facility and to deliver Product to Buyer, including Energy from the Facility to the Delivery Point;

(v) Seller shall maintain Site Control required for the operation of the Facility at the Site and the performance of any obligations of Seller hereunder;

(vi) Seller shall cause its employees to comply with the Occupational Safety and Health Act, and the rules promulgated thereunder by the U.S. Department of Labor, and all applicable California statutes and regulations affecting job safety; and

(vii) Seller shall comply with all federal, state and local laws, statutes, ordinances, rules and regulations, and the orders and decrees of any courts or administrative

bodies or tribunals, including, without limitation employment discrimination laws and prevailing wage laws.

#### **5.4 Buyer's Financial Security.**

(a) Buyer shall not be required to post financial security during the Term. During the Delivery Term, the Contract Price shall be determined based on whether Buyer has provided Qualifying Credit Support. In the event, on or before April 21, 2021, Buyer either (i) obtains an investment-grade credit rating on its long-term, unsecured indebtedness with either Moody's or S&P; or (ii) posts financial security in the amount of [REDACTED] in the form of a Letter of Credit from a Qualified Institution, a cash deposit, or a combination thereof ("Buyer Financial Security"), then from such date forward for so long as Buyer maintains such credit-rating or credit support, Buyer shall pay "Contract Price B" as set forth in **Exhibit A**. At all other times, Buyer shall pay "Contract Price A" as set forth in **Exhibit A**.

(b) If Buyer elects, in its sole discretion, to post Buyer Financial Security, Seller shall have the right to draw upon the Buyer Financial Security, at Seller's sole discretion, in the event Buyer fails to make any payments owing under this Agreement or to reimburse Seller for costs or damages that Seller has incurred as a result of Buyer's failure to perform under this Agreement. Within five (5) Business Days following any draw by Seller on the Buyer Financial Security, Buyer shall replenish the amount drawn such that the Buyer Financial Security is restored to the full amount; *provided* that in no event shall the maximum recovery by Seller under the Buyer Financial Security exceed [REDACTED]. Seller shall release the Buyer Financial Security, less amounts drawn, if any, to Buyer upon the earlier of (i) termination of this Agreement in accordance with its terms; (ii) on the tenth (10th) Business Day after the expiration of the Term; and (iii) on the tenth (10th) Business Day after the date upon which Buyer provides evidences that it has achieved an investment-grade credit rating on its long-term, unsecured indebtedness with either Moody's or S&P; *provided* that in the event of a subsequent downgrade or loss of such credit rating, Buyer will, within ten (10) Business Days, provide Seller with replacement Buyer Financial Security or begin paying "Contract Price A", as set forth in **Exhibit A**, for subsequent Energy deliveries.

(c) With respect to any Letter of Credit posted hereunder, on or before the date that is thirty (30) days prior to the expiration date of any Letter of Credit, Buyer shall cause the Letter of Credit to be renewed or replaced with another Letter of Credit in an equal amount. Seller shall have the right to draw on a Letter of Credit, at Seller's sole discretion if (A) such Letter of Credit has not been renewed or replaced at least thirty (30) days prior to the date of its expiration or (B) the issuer is no longer a Qualified Institution and Buyer has not caused a replacement Letter of Credit to be issued for the benefit of Seller within ten (10) Business Days of such issuer no longer qualifying as a Qualified Institution; *provided* that if Seller draws upon any Letter of Credit for the foregoing reasons and Buyer subsequently posts a replacement Letter of Credit or extends or renews a Letter of Credit (in the case of (A) above), the proceeds of Seller's drawing shall be returned to Buyer.

#### **5.5 Guaranteed Energy Production.**

(a) Guaranteed Energy Production.

(i) During each Performance Period, Seller shall deliver to Buyer an amount of Buyer's Allocation of Energy together with Excused Energy no less than eight-five percent (85%) of the sum of the Minimum Annual Energy Production corresponding to the two (2) Contract Years of the Performance Period (the "Guaranteed Energy Production").

(ii) In the event Seller's deliveries of Buyer's Allocation of Energy together with Excused Energy are less than eight-five percent (85%) of the sum of the Minimum Annual Energy Production corresponding to the two (2) Contract Years of the Performance Period (the difference a "Shortfall Amount"), Buyer shall be entitled to receive liquidated damages in the amount of the Shortfall Amount multiplied by [REDACTED] (the "GEP Damages").

(iii) Within thirty (30) Days of the end of each Contract Year, Seller shall provide to Buyer Seller's calculation of Buyer's Allocation of Energy delivered to the Delivery Point together with Excused Energy during the preceding Contract Year. Buyer shall have thirty (30) days following receipt of such calculation to dispute the calculation therein, after which time the calculation shall be binding on the Parties. Any disputes regarding such calculation shall be resolved pursuant to Section 8.16.

(iv) Within sixty (60) Days of the end of each Performance Period, Buyer shall provide notice to Seller if Seller failed to satisfy the Guaranteed Energy Production along with Buyer's calculation of the GEP Damages; provided, however, that Buyer's failure to provide such notice shall not constitute as a waiver of Buyer's rights to collect GEP Damages.

(v) The Parties agree and acknowledge that the damages sustained by Buyer associated with Seller's failure to satisfy the Guaranteed Energy Production would be difficult or impossible to determine, or that obtaining an adequate remedy would be unreasonably time consuming or expensive, and therefore agree that the GEP Damages are a reasonable approximation of such damages. Buyer shall have the right to set off any GEP Damages against payments due to Seller.

## **5.6 Access Rights.**

Upon reasonable prior notice and subject to compliance with the prudent safety requirements of Seller, and Applicable Law relating to workplace health and safety, Seller shall provide Buyer and its authorized agents, employees, contractors and inspectors with reasonable access to the Facility: (a) for the purpose of reading or testing metering equipment; and, (b) for other reasonable purposes at the reasonable request of Buyer; *provided*, such access shall take place during normal business hours and Buyer shall observe all applicable safety rules made known to Buyer's employees, contractors and authorized agents and shall indemnify Seller for the actions of its employees, contractors and authorized agents for harm or liabilities caused by Buyer, its employees, contractors or authorized agents during such Site visits. Buyer shall indemnify and release Seller against and from any and all liabilities resulting from actions or omissions in connection with Buyer's visits to the Site, except to the extent that such damages are caused or exacerbated by the intentional or negligent act or omission of Seller or Seller's contractors.

### **5.7 Facility Images.**

Buyer shall not, without the prior consent of Seller (such consent not unreasonably withheld, conditioned or delayed) use any images from or of the Facility for promotional purposes.

## **ARTICLE 6 INDEMNIFICATION AND INSURANCE**

### **6.1 Indemnity.**

(a) Subject to Section 8.8 (waiver of certain damages), each Party hereby agrees to indemnify, defend and hold harmless the other Party, its Affiliates, directors, officers, employees and agents, from and against all claims, demands, causes of action, judgments, liabilities and associated costs and expenses (including reasonable attorney's fees) arising from property damage, bodily injuries or death suffered by any Person (including, without limitation, employees of Buyer or Seller) related to, arising from, or connected to the negligent acts, errors, omissions or willful misconduct incident to the performance of this Agreement on the part of the indemnifying party hereunder, or any of its officers, agents, employees, or subcontractors of any tier, except to the extent caused by the negligence or willful misconduct of party seeking indemnification hereunder, or its officers, agents, employees, or subcontractors of any tier.

(b) The indemnitor's liability to the indemnitee shall be reduced proportionately to the extent that an act or omission of the indemnitee may have contributed to the loss, injury, property damage, charges, fees or liability. Further, no indemnitee shall be indemnified hereunder for its loss, liability, injury and damage resulting from its sole negligence, fraud or willful misconduct. The indemnitor, upon the other Party's request, shall defend any suit asserting a claim covered by this indemnity and shall pay all costs, subject to the proportionality standard set forth above in the event of the indemnitee's contributory negligence, including reasonable legal fees, that may be incurred by the other Party in enforcing this indemnity; provided, that the indemnitor shall be entitled, at its option, to assume and control the defense with reasonable input from the indemnitee and any settlement of such suit shall first be submitted to the indemnitee for prior approval. If indemnitee fails to approve a settlement proposed by indemnitor, indemnitor may settle such claim on its behalf only, without relinquishing any rights of indemnitee. If the indemnitee fails to approve any such settlement, indemnitor's liability to the indemnitee will be capped at a level equal to the proposed settlement amount, plus attorney fees and expenses incurred by the indemnitee prior to the indemnitee's rejection of the proposed settlement. Each indemnity set forth in this Section 6.1 is a continuing obligation, separate and independent of the other obligations of each Party and survives the expiration or termination hereof. It is not necessary for a Party to incur expense or make payment before enforcing a right of indemnity conferred by this Agreement.

### **6.2 Insurance.**

(a) Seller, at its own cost and expense, shall maintain and keep in full force and effect from the date ninety (90) days after the Effective Date through the later of the date of expiration or termination of the Agreement, the following insurance coverage (collectively, the "Insurance Obligations"):



(i) Workers' Compensation Insurance for statutory obligations imposed by applicable state laws, and Employer's Liability Insurance with a minimum limit of one million dollars (\$1,000,000) for disease and injury to employees;

(ii) Commercial General Liability Insurance, including premises and operations, bodily injury, broad form property damage, products/completed operations, contractual liability and independent contractor protective liability all with minimum combined single limit liability of one million dollars (\$1,000,000);

(iii) Business Automobile Liability Insurance covering bodily injury and property damage with a combined single limit of not less than one million dollars (\$1,000,000) per occurrence. Such insurance shall cover liability arising out of Seller's use of all owned (if any), non-owned and hired automobiles in the performance of the Agreement;

(iv) Umbrella/Excess Liability Insurance, written on an "occurrence," not a "claims-made" basis, providing coverage excess of the underlying Employer's Liability, Commercial General Liability, and Business Automobile Liability insurance, on terms at least as broad as the underlying coverage, with limits of not less than ten million dollars (\$10,000,000) per occurrence and in the annual aggregate. The insurance requirements of this Section 6.2 can be provided by any combination of Seller's primary and excess liability policies; and

(v) Such insurance against loss or damage as is prudently carried by businesses operating facilities in the nature of the Facility.

(b) All insurance policies required to be obtained hereunder shall provide insurance for occurrences from the date ninety (90) days after the Effective Date through the expiration or termination of the Agreement. All insurance coverage, required by this Agreement, other than self-insurance, shall be issued by an insurer with an A.M. Best's rating of not less than "A-" or such other insurer as is reasonably acceptable to both Parties. The minimum insurance requirements specified herein do not in any way limit or relieve Seller of any obligation assumed elsewhere in this Agreement, including Seller's defense and indemnity obligations.

(c) All insurance policies shall include provisions or endorsements stating any cancellation or non-renewal of the insurance required by this Section 6.2 without thirty days (30) days prior written notice and cancellation for non-payment of premium shall be effective at least ten (10) days after the insurer provides notice of such cancellation to Buyer.

(d) The insurance required above shall apply as primary insurance to, without a right of contribution from, any other insurance maintained by or afforded to Buyer, its subsidiaries and Affiliates, and their respective officers, directors, shareholders, agents, and employees, regardless of any conflicting provision in Seller's policies to the contrary. To the extent permitted by Applicable Law, Seller and its insurers shall be required to waive all rights of recovery from or subrogation against Buyer, its subsidiaries and Affiliates, and their respective officers, directors, shareholders, agents, employees and insurers. The Commercial General Liability and Umbrella/Excess Liability insurance required above shall name Buyer, its subsidiaries and Affiliates, and their respective officers, directors, shareholders, agents and

employees, as additional insureds for liability arising out of Seller's construction, ownership or operation of the Facility.

(e) Within ninety (90) days of the Effective Date, and within three (3) days after coverage is renewed or replaced, Seller shall furnish to Buyer certificates of insurance evidencing the coverage required above, written on forms and with deductibles reasonably acceptable to Buyer. All deductibles, co-insurance and self-insured retentions applicable to the insurance above shall be paid by Seller. Buyer's receipt of certificates that do not comply with the requirements stated herein, or Seller's failure to provide certificates, shall not limit or relieve Seller of the duties and responsibility of maintaining insurance in compliance with the requirements in this Section 6.2 and shall not constitute a waiver of any of the requirements in this Section 6.2.

(f) Self-Insurance.

(i) Seller may self-insure the Insurance Obligations to the extent Seller or an Affiliate of Seller (as applicable, the "Self-Insurer"), maintains a self-insurance program under which Seller is insured; provided that, the Self-Insurer's Credit Rating is rated at Investment Grade, or better, by S&P. Seller shall provide Buyer with no less than one hundred twenty (120) days prior written notice of its intent to self-insure the Insurance Obligations.

(ii) For any period of time that the Self-Insurer is unrated by S&P or the Self-Insurer's Credit Rating is rated at less than Investment Grade by S&P, Seller shall comply with the insurance obligations applicable to it under this Section 6.2.

(iii) In the event that Seller self-insures in accordance with this Section 6.2(f), it shall not be required to comply with the insurance requirements set forth in Sections 6.2(a)-6.2(e).

(iv) The minimum insurance requirements specified herein do not in any way limit or relieve Seller of any obligation assumed elsewhere in this Agreement, including Seller's defense and indemnity obligations.

(v) Seller shall furnish to Buyer a letter of self-insurance in the event that Seller intends to self-insure in accordance with this Section 6.2(f). Seller's failure to provide the letter of self-insurance shall not limit or relieve Seller of the duties and responsibility of maintaining insurance or self-insurance in compliance with the requirements in this Section 6.2 and shall not constitute a waiver of any of the requirements in this Section 6.2 by Buyer.

## ARTICLE 7 GOVERNMENT APPROVALS

### 7.1 *Government Approvals – Seller's Obligation.*

Seller shall secure and maintain, at no cost to Buyer, all Permits (including environmental permits), easements, rights-of-way, releases and other approvals necessary for the construction,

engineering, operation and maintenance of the Facility and the performance by Seller of its obligations hereunder.

### **7.2 Government Approvals – Buyer’s Obligation.**

Buyer shall secure and maintain, at no cost to Seller, all government approvals, permits, licenses, easements, rights of way, releases and other approvals necessary for the performance by Buyer of its obligations hereunder.

### **7.3 Changes In Law.**

(a) If Seller reasonably demonstrates that a change in Applicable Law occurring after the Effective Date has increased or would reasonably be expected to increase Seller’s cost to comply with Seller’s obligations under Sections 2.10, 3.2, or 7.3 of this Agreement (such Seller-incurred costs, the “Compliance Expenditures”), then the Parties agree that the maximum aggregate amount of Compliance Expenditures Seller shall be required to bear during the Delivery Term shall be capped at [REDACTED] in aggregate (“Compliance Expenditure Cap”). Any actions required for Seller to comply with its obligations set forth in this Section 7.3(a), the cost of which will be included in the Compliance Expenditure Cap, shall be referred to collectively as the “Compliance Actions.”

(b) Seller shall promptly provide Buyer with written notice of any Compliance Expenditures incurred or expected to be incurred by Seller that Seller reasonably believes should be counted against the Compliance Expenditure Cap, and the Parties shall maintain a running balance of such cost. If Seller reasonably anticipates the need to incur Compliance Expenditures in excess of the Compliance Expenditure Cap, Seller shall promptly notify Buyer of such Compliance Expenditures. Buyer shall have thirty (30) Days from the receipt of such Notice to evaluate such Notice (during which time period Seller is not obligated to incur out-of-pocket expenses in excess of the Compliance Expenditure Cap) and shall, within such time, either (1) agree to reimburse Seller for the Compliance Expenditure amount that exceeds the Compliance Expenditure Cap (such Buyer-agreed upon costs, the “Accepted Compliance Expenditures”), or (2) waive Seller’s obligation to take the identified Compliance Actions. If Buyer does not respond to a Notice given by Seller under this Section 3.3(b) within thirty (30) days after Buyer’s receipt of same, Buyer shall be deemed to have waived its rights to require Seller to take the Compliance Actions that are the subject of the Notice, and Seller shall have no further obligation to take, and no liability for any failure to take, these Compliance Actions for the remainder of the Term. If Buyer agrees to reimburse Seller for the Accepted Compliance Expenditures, then Seller shall take such Compliance Actions covered by the Accepted Compliance Costs as agreed upon by the Parties and Buyer shall reimburse Seller for Seller’s Compliance Expenditures that exceed the Compliance Expenditure Cap within thirty (30) days from the time that Buyer receives an invoice and documentation of such costs from Seller. Notwithstanding anything herein to the contrary, in the event the identified Compliance Actions are required by Applicable Law and would result in Compliance Expenditures above the Compliance Expenditure Cap, Seller shall be entitled to set off Compliance Expenditures above the Compliance Expenditure Cap against any amount that Seller shall owe to Buyer. In the event Seller reasonably determines that Seller will not owe Buyer sufficient amounts over a subsequent twelve (12) month period for Seller to offset the full amount owed to Buyer pursuant to this Section 7.3(b), Seller may issue a

request for payment of the full amount owned to Seller, and Buyer shall reimburse Seller for such amount within thirty (30) Days of receipt of Seller's Notice described above. If Buyer fails to make timely payment of such amount, Seller shall be entitled to pursue remedies as provided in Section 3.4(b).

## **ARTICLE 8 MISCELLANEOUS**

### **8.1 *Confidential Information.***

(a) The Parties have and will develop certain information, processes, know-how, techniques and procedures concerning the Facility that they consider confidential and proprietary (together with the terms and conditions of this Agreement, the "Confidential Information"); provided that in order for such information, processes, know-how, techniques and procedures to be considered "Confidential Information," the Party disclosing such information must: (i) if disclosure is in writing or other tangible electronic storage medium, clearly mark such item as "Confidential" or "Proprietary" or (ii) if the disclosure is oral or visual, the disclosing Party must, within three (3) Business Days thereafter, follow up with a disclosure complying with the requirements of clause (i) above. Notwithstanding the confidential and proprietary nature of such Confidential Information, the Parties (each, the "Disclosing Party") may make such Confidential Information available to the other (each, a "Receiving Party") subject to the provisions of this Section 8.1.

(b) Upon receiving or learning of Confidential Information, the Receiving Party shall:

(i) Treat such Confidential Information as confidential and use reasonable care not to divulge such Confidential Information to any third party except as required by Applicable Law, subject to the restrictions set forth below;

(ii) Restrict access to such Confidential Information to only those officers, directors, members, shareholders, affiliates, employees, contractors, subcontractors, suppliers, vendors, and advisors and prospective or actual Lenders or investors (and their officers, directors, employee and advisors) whose access is reasonably necessary for the development, construction, operation or maintenance, financing or sale of all or a portion of the Facility and for the purposes of the negotiation or implementation of this Agreement, and who shall be bound by the terms of this Section 8.1;

(iii) Use such Confidential Information solely for the purpose of developing the Facility and for the purposes set forth in this Section 8.1; and

(iv) Upon the receipt of a written request from the Disclosing Party following termination of this Agreement, except due to breach by the Disclosing Party, destroy or return any such Confidential Information in written or other tangible form and any copies thereof.

(c) The restrictions of this Section 8.1 do not apply to:

(i) Release of this Agreement to any Governmental Authority required for obtaining any approval or making any necessary filing; provided, that each Party agrees to

cooperate in good faith with the other to maintain the confidentiality of the provisions of this Agreement by requesting confidential treatment with all filings to the extent appropriate and permitted by Applicable Law;

(ii) Information which is, or becomes, publicly known or available other than through the action of the Receiving Party in violation of this Agreement;

(iii) Information which is in the possession of the Receiving Party prior to receipt from the Disclosing Party or which is independently developed by the Receiving Party; provided, that the Person or Persons developing such information have not had access to any Confidential Information;

(iv) Information which is received from a third party which is not known (after due inquiry) by the Receiving Party to be prohibited from disclosing such information pursuant to a contractual, fiduciary or legal obligation; and

(v) Information which is, in the reasonable written opinion of counsel of the Receiving Party, required to be disclosed pursuant to Applicable Law (including the California Public Records Act); provided, however, that the Receiving Party, prior to such disclosure, shall provide reasonable advance notice to the Disclosing Party of the time and scope of the intended disclosure in order to provide the Disclosing Party an opportunity to obtain a protective order or otherwise seek to prevent, limit the scope of, or impose conditions upon such disclosure.

(d) Notwithstanding the foregoing, Seller may disclose Confidential Information to the Lenders and any other financial institutions expressing an interest in providing equity or debt financing or refinancing or credit support to Seller or investing in or purchasing all or a portion of the Facility, and the agent or trustee or officers, directors, employees or advisors of any of them. Any such disclosed information will be subject to the obligations concerning confidentiality set forth in this Agreement. Seller shall be responsible for any breach of this Section 8.1 by the Lenders or such other financial institutions.

(e) Notwithstanding the foregoing, Seller or Buyer may disclose Confidential Information to WREGIS, CAISO or other Governmental Authorities for purposes of regulatory compliance or ensuring that Buyer receives the benefit of, or credit for, Green Attributes, Capacity Rights, Renewable Energy Credits, and to downstream purchasers of Product; *provided* the form and content of such disclosure is subject to Seller's approval, which approval may not be unreasonably withheld, conditioned or delayed; and provided, further, that Buyer may disclose to the foregoing Governmental Authorities, without Seller's approval: (i) the Facility's name, location, interconnection characteristics, size, monthly resource forecast and historical generation, expected Commercial Operation Date, and (ii) any Confidential Information necessary (A) to schedule Energy, (B) for the generation of an e-tag or successor mechanism, or (C) export Energy out of California to obtain the benefit of any commercial advantage provided to solar energy generators by state or federal legislation favoring renewable or non-carbon generation. Any such disclosed information will be subject to the obligations concerning confidentiality set forth in this Agreement.

(f) The Parties shall cooperate with respect to the issuance of any press or publicity release or otherwise release, distribute or disseminate any information, with the intent that such information will be published (other than information that is, in the reasonable written opinion of counsel to the Disclosing Party, required to be distributed or disseminated pursuant to Applicable Law), *provided* that the Disclosing Party has given notice to, and an opportunity to prevent disclosure by, the other Party as provided in Section 8.1(c)(v)), concerning this Agreement or the participation of the other Party in the transactions contemplated hereby without the prior written approval of the other Party, which approval will not be unreasonably withheld or delayed. This provision shall not prevent the Parties from releasing information which is required to be disclosed in order to obtain permits, licenses, releases and other approvals relating to the Facility or as are necessary in order to fulfill such Party's obligations under this Agreement.

(g) The obligations of the Parties under this Section 8.1 shall remain in full force and effect for three (3) years following the expiration or termination of this Agreement.

## **8.2 Successors and Assigns; Assignment.**

(a) This Agreement shall inure to the benefit of and shall be binding upon the Parties and their respective successors and permitted assigns.

(b) Except as provided otherwise herein, neither Party may assign or transfer by this Agreement, whether voluntarily or by operation of law, and including with respect to any change in control, without the prior written consent of the other Party, which consent shall not be unreasonably withheld, delayed or conditioned.

(c) Notwithstanding anything herein to the contrary, Seller may assign this Agreement without Buyer's consent as follows:

(i) Seller may assign this Agreement to any Lenders or Tax Equity Investors providing debt or tax equity financing, as collateral security for obligations under applicable financing documents entered into with such Lenders; and

(ii) Seller may assign this Agreement to a Seller Affiliate that owns and controls a comparable Cluster 9 Project capable of performing Seller's obligations hereunder; *provided*, that to the extent such Seller-Affiliate is not able to satisfy Seller's obligations with respect to RA benefits hereunder, Seller shall continue to be obligated to provide such RA benefits or arrange Replacement RA to be provided to Buyer. In the event of a Seller assignment as contemplated above, Seller shall arrange for any required amendment or re-issuance of the Development Security or Operating Security to reflect such assignment and the Parties shall cooperate as reasonably required to effect such arrangements and to make any conforming amendments to this Agreement and Exhibits hereto and any related documents and instruments.

(b) Buyer may assign this Agreement to a financing entity that will pre-pay all of Buyer's payment obligations under this Agreement with Seller's prior written consent, which consent shall not be unreasonably withheld, delayed or conditioned; *provided* that Seller reasonably determines that the terms and conditions of such pre-payment arrangements are

satisfactory and do not adversely affect Seller or its arrangements with Lenders in any material respect.

### **8.3 Lender Rights.**

(a) Seller, without approval of Buyer, may, by security, charge or otherwise encumber its interest under this Agreement to one or more Lenders providing debt for the purposes of financing the Facility and Seller's Interconnection Facilities.

(b) Promptly after making such encumbrance, Seller shall notify Buyer in writing of the name, address, and telephone and facsimile numbers of each Lender to which Seller's interest under this Agreement has been encumbered. Such notice shall include the names of the account managers or other representatives of the Lenders to whom all written and telephonic communications may be addressed.

(c) After giving Buyer such initial notice, Seller shall promptly give Buyer notice of any change in the information provided in the initial notice or any revised notice.

(d) Upon Seller's written request, Buyer shall execute a consent to assignment to Lenders in a form substantially similar to the Lender Consent. Buyer shall, as reasonably requested by Seller and at Seller's expense (not to exceed a maximum amount of [REDACTED]), execute and deliver normal, reasonable and customary certificates, opinions and other documents (including estoppel certificates related to a tax equity financing) and to provide such other normal and customary representations or warranties (all in a form reasonably acceptable to Buyer), as may be necessary to assist Seller in consummating any debt or tax equity financing or refinancing of the Facility or any part thereof; *provided*, that Buyer shall have no obligation to provide any consent, certification, representation, information or other document, or enter into any agreement, that materially adversely affects, or could reasonably be expected to have or result in a material adverse effect on, any of Buyer's rights, benefits, risks and/or obligations under this Agreement.

### **8.4 Notices.**

Each notice, request, demand, statement or routine communication required or permitted under this Agreement, or any notice or communication that either Party may desire to deliver to the other, shall be in writing, and shall be considered delivered: (a) when received by the other Party if sent by certified U.S. mail or reputable overnight courier addressed to the other Party at its address indicated below; or (b) when electronic confirmation is received by the sending Party's facsimile machine if sent by facsimile addressed to the other Party at its facsimile number indicated below. Either Party may designate another address for itself in a written notice to the other Party in accordance with this Section 8.4.

If to Seller:                   Aquamarine Westside, LLC  
  c/o CIM Group, LLC  
  4700 Wilshire Blvd  
  Los Angeles, CA 90010  
  Attn: Alex Martinez and Jennifer Gandin

Telephone: 323.556.9675  
Email: [amartinez@cimgroup.com](mailto:amartinez@cimgroup.com)

With copies of all notices relating to Events of Default, termination (see Section 3.4(b)(iii)) and other legal notices by overnight mail to:

Aquamarine Westside, LLC  
c/o CIM Group, LLC  
4700 Wilshire Blvd  
Los Angeles, CA 90010  
Attn: Jennifer Gandin

With a Copy to:

Aquamarine Westside, LLC  
c/o CIM Group, LLC  
4700 Wilshire Blvd  
Los Angeles, CA 90010  
Attn: Legal/General Counsel

Dentons US LLP  
601 S. Figueroa Street  
Suite 2500  
Los Angeles, CA 90017  
Attn: Carl R. Steen, Esq.  
Telephone: 213.892.5143  
Email: [carl.steen@dentons.com](mailto:carl.steen@dentons.com)

If to Buyer: Valley Clean Energy Alliance  
604 2nd Street, Davis, California 95616  
Attn: Mitch Sears, Interim General Manager  
Telephone: (530) 446-2750

With a copy to:

Keyes & Fox LLP  
1580 N Lincoln Street, Suite 880,  
Denver, CO 80203  
Attn: Kevin T. Fox, Esq.  
Telephone: 510.381.3052  
Email: [kfox@keyesfox.com](mailto:kfox@keyesfox.com)

With copies of all notices relating to Events of Default, termination (see Section 3.4(b)(iii)) and other legal notices by overnight mail to:

Best, Best & Kreiger



500 Capitol Mall, Suite 1700,  
Sacramento, CA 95814  
Attn: Harriet Steiner  
Telephone: (916) 551-2821

## **8.5 Force Majeure.**

(a) The performance of any obligation required hereunder shall be excused to the extent required by, and during the continuation of, any Force Majeure Event suffered by the Party whose performance is hindered in respect thereof, and the time for performance of any obligation that has been delayed due to the occurrence of a Force Majeure Event shall be extended, as required to overcome the effects of such Force Majeure Event. The Party experiencing the delay or hindrance shall orally notify the other Party as soon as reasonably practicable following the Force Majeure Event, and shall notify the other Party in writing of the occurrence of such Force Majeure Event, including the nature, cause, date and time of commencement of such event, and extent and anticipated period of delay, within fourteen (14) Days after the commencement of the Force Majeure Event; provided, that the failure of the Party experiencing the delay or hindrance to notify the other Party within such fourteen (14) Day period shall preclude such Party from claiming a Force Majeure Event hereunder for any Days prior to its notice. By way of example, if a Party first notifies the other Party of a Force Majeure Event thirty (30) Days after the commencement of such event, the claiming Party will only have its performance excused by reason of such Force Majeure Event for periods after its notice (i.e., on and after day thirty (30)). Each Party suffering a Force Majeure Event shall take, or cause to be taken, such action as may be necessary to overcome or otherwise to mitigate, in all material respects, the effects of any Force Majeure Event suffered by either of them and to resume performance hereunder as soon as practicable under the circumstances.

(b) If Seller is unable to deliver, or Buyer is unable to receive, Buyer's Allocation of Energy due to a Force Majeure Event, then Buyer shall have no obligation to pay Seller for Buyer's Allocation of Energy not delivered or received by reason thereof. In no event shall Buyer be obligated to compensate Seller or any other Person for any losses, expenses or liabilities that Seller or such other Person may sustain as a consequence of any Force Majeure. In no event shall any delay or failure of performance caused by any conditions or Force Majeure Event extend this Agreement beyond its stated Term.

(c) Either Party shall have the absolute and unconditional right, but not the obligation, to terminate this Agreement upon thirty (30) Days written notice to the other Party if: (i) a Force Majeure Event occurs that diminishes the Energy generating capacity of the Facility such that Seller is unable to deliver to Buyer at least fifty percent (50%) of the Expected Energy for a period of eighteen (18) consecutive months; or (ii) the Facility is damaged as a result of a Force Majeure Event and thereby rendered inoperable and an independent engineer that is mutually acceptable to the Parties determines that the Facility cannot be repaired or replaced within a period of time not to exceed twenty four (24) months following the date of the occurrence of the Force Majeure event; or (iii) if a Force Majeure Event prevents the other Party from performing its material obligations under this Agreement for a period of twelve (12) consecutive months or longer.

(d) A Party's exercise of its termination right pursuant to Section 8.5(c) shall be "no-fault" and no Party shall have any liability or obligation to the other Party arising out of such termination. Notwithstanding the foregoing, upon any such termination, each Party shall pay the other Party for any and all amounts hereunder that may be owing, including for any outstanding payments due in the ordinary course that occurred prior to the termination, and Buyer shall return Seller's Operating Security (less any amounts drawn by Buyer pursuant to this Agreement) within five (5) Business Days of such termination.

#### **8.6 *Amendments.***

This Agreement shall not be modified nor amended unless such modification or amendment shall be in writing and signed by authorized representatives of both Parties.

#### **8.7 *Waivers.***

Failure to enforce any right or obligation by any Party with respect to any matter arising in connection with this Agreement shall not constitute a waiver as to that matter nor to any other matter. Any waiver by any Party of its rights with respect to a default under this Agreement or with respect to any other matters arising in connection with this Agreement must be in writing. Such waiver shall not be deemed a waiver with respect to any subsequent default or other matter.

#### **8.8 *Waiver of Certain Damages.***

Notwithstanding any other provision of this Agreement, except to the extent indemnification payments are made pursuant to this Agreement as a result of an indemnified entity's obligation to pay special, indirect, incidental, punitive or consequential damages to a third party (excluding either Party's Affiliates, officers, directors, shareholders or members) as a result of actions included in the protection afforded by the indemnification provisions hereof, and except with respect to the liquidated damages provided for in Sections 2.5(d), 2.5(e), 2.5(f) and 5.5(a), neither Buyer nor Seller (nor any of their Affiliates, contractors, consultants, officers, directors, shareholders, members or employees) shall be liable for special, indirect, incidental, punitive or consequential damages under, arising out of, due to, or in connection with its performance or non-performance of this Agreement or any of its obligations herein, whether based on contract, tort (including, without limitation, negligence), strict liability, warranty, indemnity or otherwise.

#### **8.9 *No Recourse to Members***

Seller hereby acknowledges and agrees that Buyer is organized as a Joint Powers Authority in accordance with the Joint Powers Act of the State of California (Government Code Section 6500 et seq.) pursuant to an agreement executed by the Cities of Davis and Woodland, and the County of Yolo (the "Joint Power Agreement"), that Buyer is a public entity separate from its members, and that under the Joint Powers Agreement the members have no liability for any obligations or liabilities of Buyer. Buyer hereby acknowledges and agrees that Seller is an entity separate from its members and, except as expressly provided for herein, Seller's members have no liability for any obligations or liabilities of Seller. The Parties shall solely be responsible for all debts, obligations and liabilities accruing and arising out of this Agreement, and the Parties agree that

they shall have no rights against, and shall not make any claim, take any actions or assert any remedies against, any of Buyer's or Seller's members, any cities or counties participating in Buyer's community choice aggregation program, or any of Buyer's retail customers in connection with this Agreement.

#### **8.10 *Survival.***

Notwithstanding any provisions herein to the contrary, the obligations set forth in Sections 2.2(c), 4.1, 4.3, 6.1, 8.1, 8.4, 8.8, 8.9, and 8.12 through 8.16 shall survive (in full force) the expiration or termination of this Agreement.

#### **8.11 *Severability.***

If any of the terms of this Agreement are finally held or determined to be invalid, illegal or void, all other terms of the Agreement shall remain in effect, provided that the Parties shall enter into negotiations concerning the terms affected by such decision for the purpose of achieving conformity with requirements of any Applicable Law and the original intent of the Parties.

#### **8.12 *Standard of Review.***

(a) Each Party represents and warrants to the other that it is an "eligible commercial entity" and an "eligible contract participant" within the meaning of United States Commodity Exchange Act §§1a(17) and 1a(18), respectively. This Agreement constitutes a sale of a nonfinancial commodity for deferred shipment or delivery that the Parties intend to be physically settled and is excluded from the term "swap" as defined in the Commodity Exchange Act under 7 U.S.C. § 1a(47) and the regulations of the Commodity Future Trading Commission and Securities and Exchange Commission, with further reference to 77 Fed. Reg. 48233-35.

(b) Absent the agreement of both Parties to a proposed change, the standard of review for changes to any rate, charge, classification, term or condition of this Agreement, whether proposed by a Party (to the extent that any waiver in subsection (c) below is unenforceable or ineffective as to such Party), a non-party or FERC acting *sua sponte*, shall solely be the "public interest" application of the "just and reasonable" standard of review set forth in United Gas Pipe Line Co. v. Mobile Gas Service Corp., 350 U.S. 332 (1956) and Federal Power Commission v. Sierra Pacific Power Co., 350 U.S. 348 (1956) and clarified by Morgan Stanley Capital Group, Inc. v. Public Util. Dist. No. 1, 554 U.S. 527 (2008), and NRG Power Marketing LLC v. Maine Public Utility Commission, 558 U.S. 527 (2010) (the "Mobile-Sierra" doctrine).

(c) In addition, and notwithstanding the foregoing subsection (a), to the fullest extent permitted by Applicable Law, each Party, for itself and its successors and assigns, hereby expressly and irrevocably waives any rights it can or may have, now or in the future, whether under §§ 205 or 206 of the Federal Power Act or otherwise, to seek to obtain from FERC by any means, directly or indirectly (through complaint, investigation or otherwise), and each hereby covenants and agrees not at any time to seek to so obtain, an order from FERC changing any section of this Agreement specifying the rate, charge, classification, or other term or condition agreed to by the Parties, it being the express intent of the Parties that, to the fullest extent permitted by Applicable Law, neither Party shall unilaterally seek to obtain from FERC any

relief changing the rate, charge, classification, or other term or condition of this Agreement, notwithstanding any subsequent changes in Applicable Law or market conditions that may occur. In the event it were to be determined that Applicable Law precludes the Parties from waiving their rights to seek changes from FERC to their market-based power sales contracts (including entering into covenants not to do so) then this subsection (c) shall not apply, provided that, consistent with the foregoing subsection (b), neither Party shall seek any such changes except solely under the “public interest” application of the “just and reasonable” standard of review and otherwise as set forth in the foregoing section (b).

### **8.13 *Governing Law.***

This Agreement and the rights and duties of the Parties hereunder shall be governed by and construed, enforced and performed in accordance with the laws of the State of California, without regard to principles of conflicts of law.

### **8.14 *Consent to Jurisdiction.***

Subject to Section 8.15, each of the Parties irrevocably and unconditionally submits to the exclusive jurisdiction of the Superior Court of Sacramento County, California for the purposes of any suit, action or other proceeding arising out of or relating to this Agreement, the transactions contemplated hereby, any provision hereof or the breach, performance, enforcement or validity or invalidity of this Agreement or any provision hereof (and agrees not to commence any suit, action or proceeding relating thereto except in such court). Each of the Parties further agrees that service of any process, summons, notice or document hand delivered or sent by U.S. registered mail to such Party’s respective address set forth in Section 8.4 will be effective service of process for any suit, action or proceeding in any such court with respect to any matters to which it has submitted to jurisdiction as set forth in the immediately preceding sentence. Each of the Parties irrevocably and unconditionally waives any objection to the laying of venue of any suit, action or proceeding arising out of or relating to this Agreement, the transactions contemplated hereby, any provision hereof or the breach, performance, enforcement or validity or invalidity of this Agreement or any provision hereof in the Superior Court of Sacramento County, California and hereby further irrevocably and unconditionally waives and agrees not to plead or claim in any such court that any such suit, action or proceeding brought in any such court has been brought in an inconvenient forum. Notwithstanding the foregoing, each Party agrees that a final judgment (i.e., judgment after any appeals that may be duly made) in any suit, action or proceeding so brought shall be conclusive and may be enforced by suit on the judgment in any jurisdiction or in any other manner provided in law or in equity.

### **8.15 *Waiver of Trial by Jury.***

EACH OF THE PARTIES HERETO HEREBY KNOWINGLY, VOLUNTARILY AND INTENTIONALLY WAIVES THE RIGHT EITHER OF THEM MAY HAVE TO A TRIAL BY JURY IN RESPECT OF ANY LITIGATION BASED HEREON, OR ARISING OUT OF, UNDER OR IN CONNECTION WITH THIS AGREEMENT AND ANY AGREEMENT CONTEMPLATED TO BE EXECUTED IN CONJUNCTION HEREWITH, OR ANY COURSE OF CONDUCT, COURSE OF DEALING, STATEMENTS (WHETHER VERBAL

OR WRITTEN) OR ACTIONS OF ANY PARTY HERETO. THIS PROVISION IS A MATERIAL INDUCEMENT FOR THE PARTIES ENTERING INTO THIS AGREEMENT.

**8.16 *Disputes.***

In the event of any dispute, controversy or claim between the Parties arising out of or relating to this Agreement (collectively, a “Dispute”), the Parties shall attempt in the first instance to resolve such Dispute through friendly consultations between the Parties. If such consultations do not result in a resolution of the Dispute within thirty (30) days after notice of the Dispute has been delivered to either Party, then such Dispute shall be referred to the senior management of the Parties for resolution. If the Dispute has not been resolved within thirty (30) days after such referral to the senior management of the Parties, then either Party may pursue any or all of its remedies available under law or equity. The Parties agree to attempt to resolve all Disputes promptly, equitably and in a good faith manner, provided, however, that failure to resolve a Dispute shall not, standing alone, constitute a breach of this Agreement. Notwithstanding the existence of a Dispute, each Party shall fulfill its obligations in accordance with the terms hereof. Any undisputed payment due or payable by one Party to the other shall not be withheld on account of the occurrence or continuance of any legal proceedings or the existence of a Dispute.

**8.17 *No Third-Party Beneficiaries.***

Except as set forth in a Lender Consent or the indemnification provisions hereof that expressly accrue to the benefit of third parties, this Agreement is intended solely for the benefit of the Parties hereto and nothing contained herein shall be construed to create any duty to, or standard of care with reference to, or any liability to, or any benefit for, any Person not a Party to this Agreement.

**8.18 *No Agency.***

This Agreement is not intended, and shall not be construed, to create any association, joint venture or partnership between the Parties or to impose any such obligation or liability upon either Party. Except for the agency Seller grants Buyer in Section 3.2(c), neither Party shall have any right, power or authority to enter into any agreement or undertaking for, or act as or be an agent or representative of, or otherwise bind, the other Party.

**8.19 *Cooperation.***

The Parties acknowledge that they are entering into a long-term arrangement in which the cooperation of both of them will be required. If, during the Term, changes in the operations, facilities or methods of either Party will materially benefit a Party without detriment to the other Party, the Parties commit to each other to make reasonable efforts to cooperate and assist each other in making such change.

**8.20 *Further Assurances.***

Upon the receipt of a written request from the other Party, each Party shall execute such additional documents, instruments and assurances and take such additional actions as are

reasonably necessary and desirable to carry out the terms and intent hereof. Neither Party shall unreasonably withhold, condition or delay its compliance with any reasonable request made pursuant to this Section 8.20.

**8.21 *Captions; Construction.***

All indexes, titles, subject headings, section titles, and similar items are provided for the purpose of reference and convenience and are not intended to affect the meaning of the content or scope of this Agreement. Any term and provision of this Agreement shall be construed simply according to its fair meaning and not strictly for or against any Party.

**8.22 *Entire Agreement.***

This Agreement shall supersede all other prior and contemporaneous understandings or agreements, both written and oral, between the Parties relating to the subject matter of this Agreement.

**8.23 *Counterparts.***

This Agreement may be executed in several counterparts, each of which shall be an original and all of which together shall constitute but one and the same instrument.

**8.24 *Forward Contract.***

The Parties acknowledge and agree that this Agreement and the transactions contemplated by this Agreement constitute a “forward contract” Code and that Buyer and Seller are each “forward contract merchants” within the meaning of the United States Bankruptcy Code (11 U.S.C. § 101 (2000)).

***[REMAINDER OF PAGE INTENTIONALLY LEFT BLANK –  
SIGNATURES APPEAR ON FOLLOWING PAGE]***

IN WITNESS WHEREOF, representatives of the Parties have executed this Agreement on the date set forth below, causing this Agreement to be effective as of the Effective Date:

**Aquamarine Westside, LLC**

By:  \_\_\_\_\_

Name: David Thompson  
Vice President

Title: and  
Chief Financial Officer

Date: 1/31/2020

**Valley Clean Energy Alliance**

By: \_\_\_\_\_

Name: \_\_\_\_\_

Title: \_\_\_\_\_

Date: \_\_\_\_\_

**EXHIBIT A**

**CONTRACT PRICE**

The Contract Price for all Product shall be:

Contract Price A: [REDACTED]; or

Contract Price B: [REDACTED] (following Buyer's provision of Financial Security as set forth in Section 5.4).



**EXHIBIT B**

**DESCRIPTION OF FACILITY**

1. Facility name:

Aquamarine Solar

2. Facility location:

The Facility is located just south of the intersection of South Avenal Cutoff & 25<sup>th</sup> Avenue in Kings County, in the State of California

3. Technology type:

Solar photovoltaic

4. Interconnection Point of Facility:

The Facility's Interconnection Point shall be Gates 230 kV, which is the point of first interconnection of the Facility with the CAISO Controlled Grid

5. Service territory of the Facility:

Pacific Gas & Electric Company

6. Description of Facility equipment:

[full description of equipment that will be used]

7. Description of Site:

The Aquamarine solar project is located along 25th avenue south of Avenal Cutoff Road in Kings County, CA. The site will encompass between 1,825-2,000 acres of drainage impaired farm ground that pursuant to approved CUP 17-04 in Kings County, CA using the address 24999 Laurel Avenue, Stratford, CA.

8. Maps:

The Facility is identified in the following map:

**EXHIBIT B-1  
FACILITY SITE PLAN**

The Facility will be located at the Site as show on the map below:

Located in the County of Kings, California

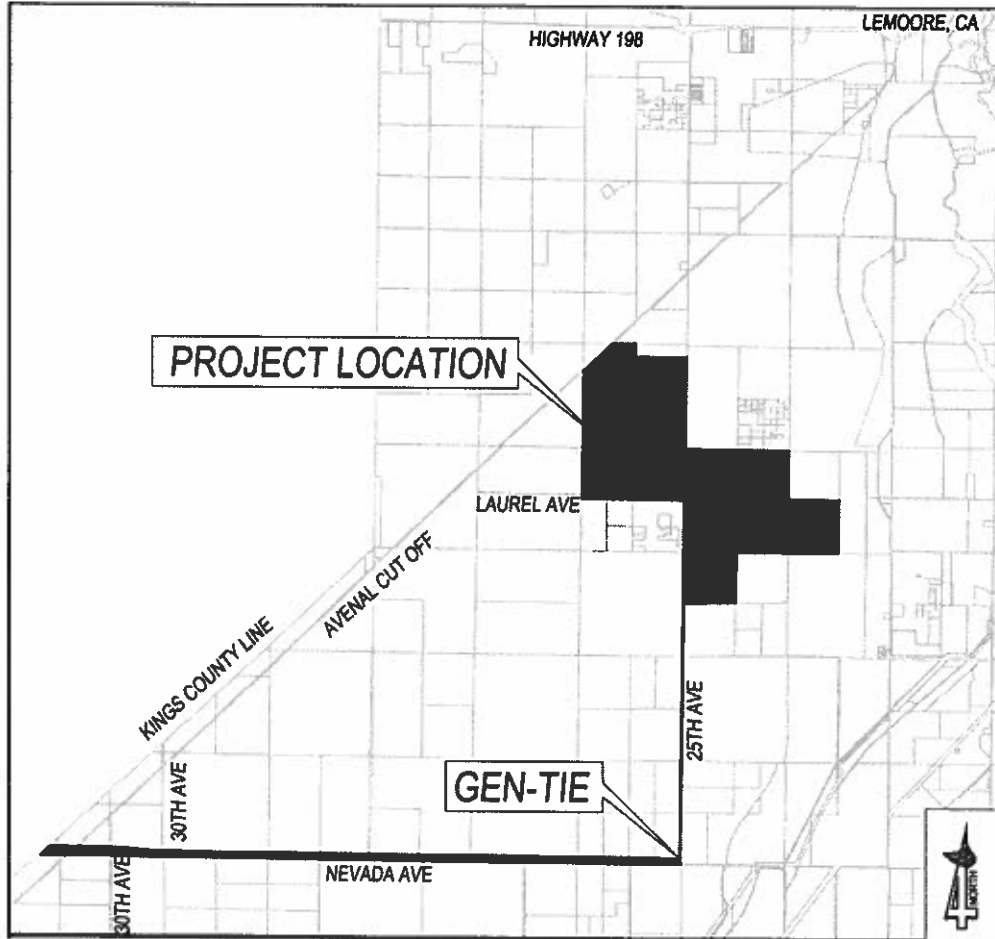

**EXHIBIT C**

**DESCRIPTION OF INTERCONNECTION POINT, DELIVERY POINT, AND ONE-LINE/METERING DIAGRAM**

The Facility is connecting to the Gates 230kv PG&E Substation in Fresno County, CA a representation of the single line diagram from the interconnection agreement is included here:

**Conceptual Single Line Diagram of Aquamarine Westside Q1117**

**Figure C-1**

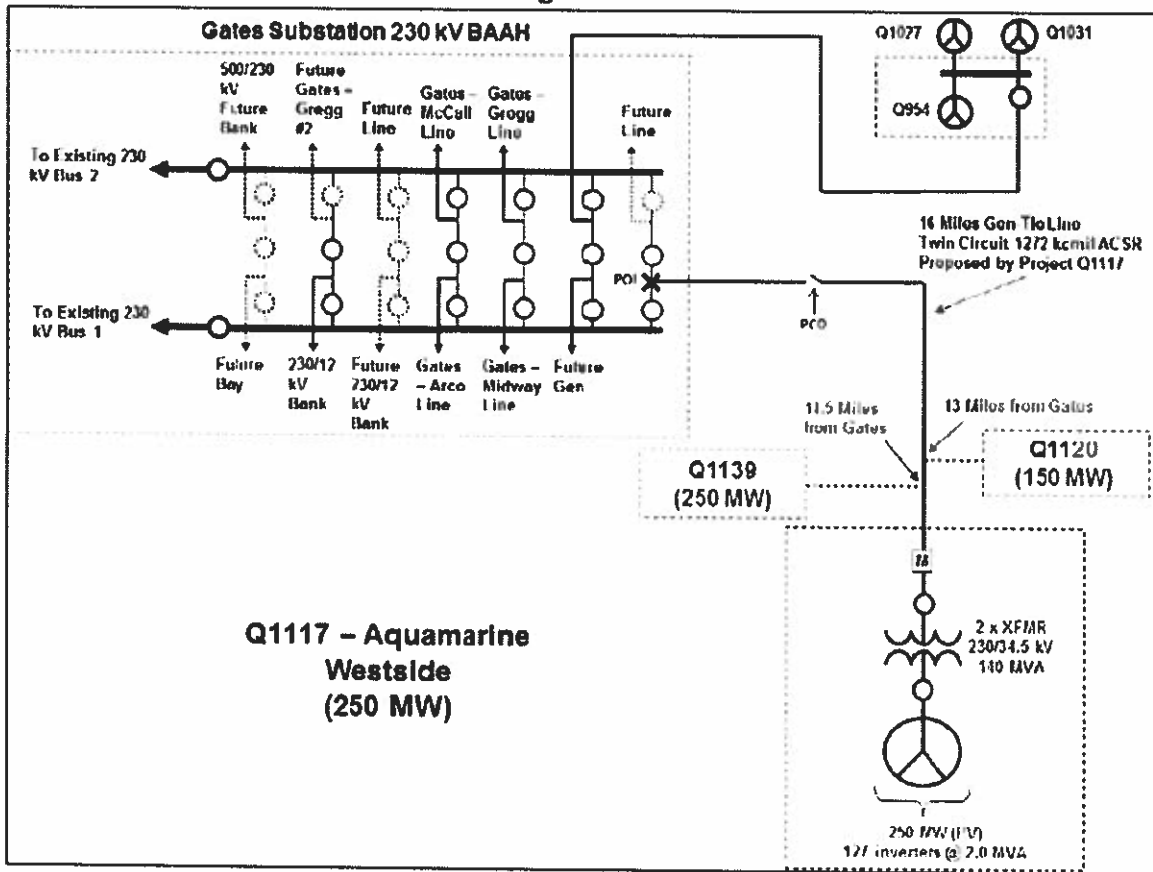

## **EXHIBIT D**

### **FORM OF CORPORATE GUARANTY**

#### **GUARANTY**

This Guaranty (this "**Guaranty**"), dated as of \_\_\_\_\_, \_\_\_\_\_ (the "**Effective Date**"), is made by [\_\_\_\_\_] ("**Guarantor**"), in favor of VALLEY CLEAN ENERGY ALLIANCE ("**Counterparty**").

#### **RECITALS**

**WHEREAS**, Counterparty and Guarantor's subsidiary Aquamarine Westside, LLC ("**Obligor**") have entered into that certain Power Purchase Agreement dated as of November \_\_, 2019 (the "**Agreement**"); and

**WHEREAS**, Guarantor will directly or indirectly benefit from the transaction to be entered into between Obligor and Counterparty pursuant to the Agreement.

**NOW THEREFORE**, in consideration of the foregoing premises and as an inducement for Counterparty's execution, delivery and performance of the Agreement, and for other good and valuable consideration, the receipt and sufficiency of which is hereby acknowledged, Guarantor hereby agrees for the benefit of Counterparty as follows:

1. **Guaranty.** Subject to the terms and provisions hereof, Guarantor hereby absolutely and irrevocably guarantees the timely payment when due of all obligations owing by Obligor to Counterparty arising pursuant to the Agreement on or after the Effective Date (the "**Guaranteed Obligations**"). This Guaranty shall constitute a guarantee of payment and not merely of collection. The liability of Guarantor under this Guaranty shall be primary to the Guarantor and unconditional subject to the following limitations:

(a) Notwithstanding anything herein or in the Agreement to the contrary, the maximum aggregate obligation and liability of Guarantor under this Guaranty, and the maximum recovery from Guarantor under this Guaranty, shall in no event exceed \_\_\_\_\_, exclusive of Counterparty's costs of collection and enforcement under Section 1(b) (the "**Maximum Recovery Amount**"). This Guaranty is a continuing guaranty of payment and shall apply to all Obligations whenever arising.

(b) The obligation and liability of Guarantor under this Guaranty is specifically limited to payments expressly required to be made under the Agreement, as well as costs of collection and enforcement of this Guaranty (including attorney's fees) to the extent reasonably and actually incurred by the Counterparty. In no event, however, shall Guarantor be liable for or obligated to pay any consequential, indirect, incidental, lost profit, special, exemplary, punitive, equitable or tort damages, except to the extent such damages are allowed under the Agreement.

**2. Demands and Payment.**

(a) If Obligor fails to pay any Guaranteed Obligation to Counterparty when such Obligation is due and owing under the Agreement, Counterparty may present a written demand to Guarantor calling for Guarantor's payment of such Guaranteed Obligation pursuant to this Guaranty (a "**Payment Demand**").

(b) Guarantor's obligation hereunder to pay any particular Guaranteed Obligation(s) to Counterparty is conditioned upon Guarantor's receipt of a Payment Demand from Counterparty satisfying the following requirements: (i) such Payment Demand must identify the specific Guaranteed Obligation(s) covered by such demand, the specific date(s) upon which such Guaranteed Obligation(s) became due and owing under the Agreement, and the specific provision(s) of the Agreement pursuant to which such Guaranteed Obligation(s) became due and owing; (ii) such Payment Demand must be delivered to Guarantor in accordance with Section 9 below; and (iii) the specific Guaranteed Obligation(s) addressed by such Payment Demand must remain due and unpaid at the time of such delivery to Guarantor.

(c) After issuing a Payment Demand in accordance with the requirements specified in Section 2(b) above, Counterparty shall not be required to issue any further notices or make any further demands with respect to the Guaranteed Obligation(s) specified in that Payment Demand, and Guarantor shall be required to make payment with respect to the Guaranteed Obligation(s) specified in that Payment Demand within three (3) Business Days after Guarantor receives such demand. As used herein, the term "Business Day" shall mean all weekdays (i.e., Monday through Friday) other than any weekdays during which commercial banks or financial institutions are authorized to be closed to the public in the State of Colorado or the State of New York.

**3. Representations and Warranties.** Guarantor represents and warrants that:

(a) it is a [\_\_\_\_\_] duly organized and validly existing under the laws of the State of [\_\_\_\_\_] and has the corporate power and authority to execute, deliver and carry out the terms and provisions of the Guaranty;

(b) no authorization, approval, consent or order of, or registration or filing with, any court or other governmental body having jurisdiction over Guarantor is required on the part of Guarantor for the execution and delivery of this Guaranty; and

(c) this Guaranty constitutes a valid and legally binding agreement of Guarantor, enforceable against Guarantor in accordance with the terms hereof, except as the enforceability thereof may be limited by the effect of any applicable bankruptcy, insolvency, reorganization, moratorium or similar laws affecting creditors' rights generally and by general principles of equity.

**4. No Counterclaims or Setoffs; Deferral of Defenses.** The obligations of the Guarantor to the Counterparty hereunder shall not be subject to any counter-claim, set-off, withholding, or deduction unless required by applicable law, and shall not be affected by any

circumstance which constitutes a legal or equitable discharge of a guarantor other than the satisfaction of the Guaranteed Obligations. A separate action or actions may be brought against the Guarantor whether or not any action is brought against the Obligor under the Agreement and whether or not the Obligor is joined in any such action or actions. Guarantor reserves to itself all rights, setoffs, counterclaims and other defenses to which Obligor is or may be entitled arising from or out of the Agreement, except for defenses (if any) based upon the bankruptcy, insolvency, dissolution or liquidation of Obligor, any lack of power or authority of Obligor to enter into and/or perform the Agreement, and other defenses expressly waived by in this Guaranty; *provided* that the Guarantor shall not exercise any such defenses until after payment has been made pursuant to Section 2.

**5. Amendments.** Guarantor agrees that the Counterparty and the Obligor may modify, amend and supplement the Agreement and that the Counterparty may delay or extend the date on which any payment must be made pursuant to the Agreement or delay or extend the date on which any act must be performed by the Obligor thereunder, waive, exercise or refrain from exercising any rights against the Obligor, or subordinate any obligation or liability of the Obligor to the Counterparty, including any security therefor, all without notice to or further assent by the Guarantor, who shall remain bound by this Guaranty, notwithstanding any such act by the Counterparty. No term or provision of this Guaranty shall be amended, modified, altered, waived or supplemented except in a writing signed by Guarantor and Counterparty; *provided*, however, that an amendment to this Guaranty extending the termination date of this Guaranty may be executed solely by Guarantor.

**6. Waivers and Consents.** Subject to and in accordance with the terms and provisions of this Guaranty:

(a) Guarantor hereby expressly waives diligence, presentment, protest, notice, acceleration, dishonor and acceptance of this Guaranty and demand concerning the liabilities of Guarantor, and any right to require that any action or proceeding be brought against Obligor or any other person, or to require that Counterparty seek enforcement of any performance against Obligor or any other person, prior to any action against Guarantor under the terms hereof or to subrogate to any claims the Counterparty may have against the Obligor or the Obligor may have against the Counterparty.

(b) No delay by Counterparty in the exercise of (or failure by Counterparty to exercise) any rights hereunder shall operate as a waiver of such rights, a waiver of any other rights or a release of Guarantor from its obligations hereunder (with the understanding, however, that the foregoing shall not be deemed to constitute a waiver by Guarantor of any rights or defenses which Guarantor may at any time have pursuant to or in connection with any applicable statutes of limitation).

(c) Without notice to or the consent of Guarantor, and without impairing or releasing Guarantor's obligations under this Guaranty, Counterparty may: (i) change the manner, place or terms for payment of all or any of the Obligations (including renewals, extensions or other alterations of the Obligations); (ii) release Obligor or any person (other than Guarantor) from

liability for payment of all or any of the Obligations; or (iii) receive, substitute, surrender, exchange or release any collateral or other security for any or all of the Obligations.

7. **Reinstatement.** Guarantor agrees that this Guaranty shall continue to be effective or shall be reinstated, as the case may be, if all or any part of any payment made hereunder is at any time avoided or rescinded or must otherwise be restored or repaid by Counterparty as a result of the bankruptcy or insolvency of Obligor, all as though such payments had not been made.

8. **Termination.** This Guaranty shall remain in full force and effect until the earlier of (i) such time as all of the Guaranteed Obligations have been fully discharged; (ii) the satisfaction of all obligations of the Obligor under the Agreement; (iii) the Guarantor or Obligor causes this Guaranty to be replaced with one or a combination of cash, a fully effective letter of credit and/or another fully effective guaranty otherwise meeting the requirements of Section 3.6 of the Agreement, or (iv) the fifteenth (15th) anniversary of the first day of the first month following the Commercial Operation Date under the Agreement; provided that no such termination shall affect Guarantor's liability with respect to any Obligations arising under this Agreement prior to the time such termination is effective, which Obligations shall remain subject to this Guaranty.

9. **Notices.** Any Payment Demand, notice, request, instruction, correspondence or other document to be given hereunder (herein collectively called "Notice") by Counterparty to Guarantor, or by Guarantor to Counterparty, as applicable, shall be in writing and may be delivered either by (i) U.S. certified mail with postage prepaid and return receipt requested, or (ii) recognized nationwide courier service with delivery receipt requested, in either case to be delivered to the following address (or to such other U.S. address as may be specified via Notice provided by Guarantor or Counterparty, as applicable, to the other in accordance with the requirements of this Section 9):

To Guarantor:  
\_\_\_\_\_  
\_\_\_\_\_  
\_\_\_\_\_  
\_\_\_\_\_

To Counterparty:  
\_\_\_\_\_  
\_\_\_\_\_  
\_\_\_\_\_  
\_\_\_\_\_

Any Notice given in accordance with this Section 9 will (i) if delivered during the recipient's normal business hours on any given Business Day, be deemed received by the designated recipient on such date, and (ii) if not delivered during the recipient's normal business hours on

any given Business Day, be deemed received by the designated recipient at the start of the recipient's normal business hours on the next Business Day after such delivery.

**10. *Miscellaneous.***

(a) This Guaranty shall in all respects be governed by, and construed in accordance with, the laws of the State of California.

(b) This Guaranty shall be binding upon Guarantor and its successors and permitted assigns and inure to the benefit of and be enforceable by Counterparty and its successors and permitted assigns. Guarantor may not assign this Guaranty in part or in whole without the prior written consent of Counterparty. Counterparty may not assign its rights or benefits under this Guaranty in part or in whole without the prior written consent of Guarantor; provided that the Counterparty may, without prior notice to Guarantor or Obligor, make such an assignment, in conjunction with the grant or enforcement of a security interest or if otherwise required to do so under the terms of a mortgage or indenture to which Counterparty is or becomes a party.

(c) This Guaranty embodies the entire agreement and understanding between Guarantor and Counterparty and supersedes all prior agreements and understandings relating to the subject matter hereof.

(d) The headings in this Guaranty are for purposes of reference only and shall not affect the meaning hereof. Words importing the singular number hereunder shall include the plural number and vice versa, and any pronouns used herein shall be deemed to cover all genders. The term "person" as used herein means any individual, corporation, partnership, joint venture, limited liability company, association, joint-stock company, trust, unincorporated association, or government (or any agency or political subdivision thereof).

(e) Wherever possible, any provision in this Guaranty which is prohibited or unenforceable in any jurisdiction shall, as to such jurisdiction, be ineffective only to the extent of such prohibition or unenforceability without invalidating the remaining provisions hereof, and any such prohibition or unenforceability in any one jurisdiction shall not invalidate or render unenforceable such provision in any other jurisdiction.

(f) EACH OF COUNTERPARTY (BY ITS ACCEPTANCE OF THIS GUARANTY) AND GUARANTOR HEREBY IRREVOCABLY, INTENTIONALLY AND VOLUNTARILY WAIVES THE RIGHT TO TRIAL BY JURY WITH RESPECT TO ANY LEGAL PROCEEDING BASED ON, OR ARISING OUT OF, UNDER OR IN CONNECTION WITH, THIS GUARANTY OR THE AGREEMENT, OR ANY COURSE OF CONDUCT, COURSE OF DEALING, STATEMENTS (WHETHER VERBAL OR WRITTEN) OR ACTIONS OF ANY PERSON RELATING HERETO OR THERETO. THIS PROVISION IS A MATERIAL INDUCEMENT TO GUARANTOR'S EXECUTION AND DELIVERY OF THIS GUARANTY.

***[REMAINDER OF PAGE INTENTIONALLY LEFT BLANK –  
SIGNATURES APPEAR ON FOLLOWING PAGE]***



***IN WITNESS WHEREOF***, the Guarantor has executed this Guaranty on \_\_\_\_\_, 20\_\_, but it is effective as of the Effective Date

***[Guarantor]***

By: \_\_\_\_\_  
Name: \_\_\_\_\_  
Title: \_\_\_\_\_

**EXHIBIT E**

**FORM OF LENDER CONSENT  
(FINANCING)**

**FORM OF CONSENT AND AGREEMENT  
POWER PURCHASE AGREEMENT**

This CONSENT AND AGREEMENT (this "Consent"), dated as of \_\_\_\_\_, 20[ ], is executed by and between Valley Clean Energy Alliance, a Joint Powers Authority in accordance with the Joint Powers Act of the State of California (Government Code Section 6500 *et seq.*) (the "Contracting Party"), and [NAME OF COLLATERAL AGENT], as collateral agent (in such capacity, together with its successors and permitted assigns, the "Collateral Agent") for various financial institutions named from time to time as Lenders under the Credit Agreement (as defined below) and any other parties (or any of their agents) who hold any other secured indebtedness permitted to be incurred under the Credit Agreement (the Collateral Agent and all such parties collectively, the "Secured Parties").

A. Aquamarine Westside, LLC, a limited liability company organized and existing under the laws of Delaware (the "Facility Owner") owns, operates and maintains a 250 MW-AC solar energy generating facility located in Kings County, CA, from which 50 MW-AC will be sold to Valley Clean Energy Alliance (the "Facility").

B. The Contracting Party and the Facility Owner have entered into the agreement specified in Schedule I hereto (as further amended, restated, supplemented or otherwise modified from time to time in accordance with the terms thereof, the "Assigned Agreement").

C. The Borrower, the Facility Owner, the other affiliates of the Borrower as Guarantors, various financial institutions named therein from time to time as Lenders, [\_\_\_\_], as the Administrative Agent and Collateral Agent, [\_\_\_\_], as Lead Arrangers, have entered into a Credit Agreement, dated as of [\_\_\_\_] (as amended, modified or supplemented from time to time, the "Credit Agreement"), providing for the extension of the credit facilities described therein.

D. As security for the payment and performance by the Facility Owner of its obligations under the Credit Agreement and the other Financing Documents (as defined below) and for other obligations owing to the Secured Parties, the Facility Owner has assigned all of its right, title and interest in, to and under, and granted a security interest in, the Assigned Agreement to the Collateral Agent pursuant to the [Security Agreement], dated as of [\_\_\_\_] between the Facility Owner and the Collateral Agent (as amended, restated, supplemented or otherwise modified from time to time in accordance with the terms thereof, the "Security Agreement", and, together with the Credit Agreement and any other financing documents relating thereto, the "Financing Documents").

E. It is a requirement under the Credit Agreement that the Facility Owner cause the Contracting Party to execute and deliver this Consent.

NOW, THEREFORE, for good and valuable consideration, the receipt and adequacy of which is hereby acknowledged, and intending to be legally bound, the parties hereto hereby agree as follows:

1. Additional Definitions. Any capitalized terms used but not defined herein shall have the meaning ascribed to such term in the Assigned Agreement.

2. Consent to Assignment. Subject to the terms and conditions below, the Contracting Party hereby acknowledges and consents to the pledge and assignment of all right, title and interest of the Facility Owner in, to and under the Assigned Agreement by the Facility Owner to the Collateral Agent pursuant to the Security Agreement.

3. Limitations on Assignment. Collateral Agent acknowledges and confirms that, notwithstanding any provision to the contrary under applicable law or in any Financing Document or this Consent, Collateral Agent shall not assume, sell or otherwise dispose of the Assigned Agreement (whether by foreclosure sale, conveyance in lieu of foreclosure or otherwise) unless, on or before the date of any such assumption, sale or disposition, Collateral Agent or any third party, as the case may be, assuming, purchasing or otherwise acquiring the Assigned Agreement (a) cures any and all defaults of Facility Owner under the Assigned Agreement which are capable of being cured and which are not personal to the Facility Owner (e.g., a default such as bankruptcy), (b) executes and delivers to Contracting Party a written assumption of all of Facility Owner's rights and obligations under the Assigned Agreement in form and substance reasonably satisfactory to Contracting Party, (c) otherwise satisfies and complies with all requirements of the Assigned Agreement which are capable of being complied with and satisfied, and (d) is a Permitted Transferee (as defined below). Collateral Agent further acknowledges that the assignment of the Assigned Agreement is for security purposes only and, except as otherwise expressly provided in this Consent, that the Collateral Agent has no rights under the Assigned Agreement to enforce the provisions of the Assigned Agreement unless and until an event of default has occurred and is continuing under the Financing Documents between Seller and Collateral Agent (a "Financing Default"), in which case, the Collateral Agent shall be entitled to all of the rights and benefits and subject to all of the obligations which Facility Owner then has or may have under the Assigned Agreement to the same extent and in the same manner as if Collateral Agent were an original party to the Assigned Agreement.

"Permitted Transferee" means any person or entity who is at least as creditworthy as the Facility Owner on the Effective Date (as defined in the Assigned Agreement) and has, or contracts with an operator that has, at least three (3) years of experience either owning or operating solar energy generating facilities. Collateral Agent may from time to time, following the occurrence of a Financing Default, notify Contracting Party in writing of the identity of a proposed transferee of the Assigned Agreement, which proposed transferee may include Financing Provider, in connection with the enforcement of Financing Provider's rights under the Financing Documents, and Contracting Party shall, within thirty (30) Business Days of its receipt of such written notice, confirm to Financing Provider whether or not such proposed transferee is

a “Permitted Transferee” (together with a written statement of the reason(s) for any negative determination) it being understood that if Contracting Party shall fail to so respond within such thirty (30) Business Day period such proposed transferee shall be deemed to be a “Permitted Transferee”.

4. Right to Cure.

(a) From and after the date hereof and unless and until the Contracting Party shall have received written notice from the Collateral Agent that the lien of the Security Agreement has been released in full, Contracting Party shall, concurrently with the delivery of any notice of an Event of Default under the Assigned Agreement to Facility Owner (a “Default Notice”), provide a copy of such Default Notice to the Collateral Agent pursuant to Section 10 of this Consent.

(b) The Collateral Agent shall have the right, but not the obligation, following Contracting Party’s issuance of a Default Notice to the Facility Owner under the Assigned Agreement to pay all sums due under the Assigned Agreement by the Facility Owner and to perform any other act, duty or obligation required of the Facility Owner thereunder as described in Section 4(d) below; provided, that no such payment or performance shall be construed as an assumption by the Collateral Agent or any other Secured Party of any covenants, agreements or obligations of the Facility Owner under or in respect of the Assigned Agreement.

(c) The Contracting Party agrees that it will not terminate the Assigned Agreement without first giving the Collateral Agent notice and opportunity to cure as provided in Sections 4(a) and 4(d).

(d) If the Collateral Agent elects to exercise its right to cure as herein provided, it shall provide written notice to Contracting Party prior to the end of any cure period as set forth in the Assigned Agreement. If the Default Notice is issued because of a payment default by Facility Owner, the Collateral Agent shall have a period of thirty (30) days after receipt by it of notice from the Contracting Party referred to in Section 4(a) in which to cure the payment default specified in such Default Notice, or if such Termination Event is an event other than a failure to pay amounts due and owing by the Facility Owner (a “Non-monetary Event”) the Collateral Agent shall have such longer period as is required to cure such default, not to exceed ninety (90) days, so long as the Collateral Agent has commenced and is diligently pursuing appropriate action to cure such default; provided, however, that (i) if possession of the Facility is necessary to cure such Non-monetary Event and the Collateral Agent has commenced foreclosure proceedings, the Collateral Agent will be allowed a reasonable time to complete such proceedings, and (ii) if the Collateral Agent is prohibited from curing any such Non-monetary Event by any process, stay or injunction issued by any governmental authority or pursuant to any bankruptcy or insolvency proceeding or other similar proceeding involving the Facility Owner, then the time periods specified herein for curing the Non-monetary Event shall be extended for the period of such prohibition (but in no event longer than 180 days).

(e) Any curing of or attempt to cure any default shall not be construed as an assumption by the Collateral Agent or the other Secured Parties of any covenants, agreements or

obligations of the Facility Owner under or in respect of the Assigned Agreement, provided, however, if Collateral Agent, directly or indirectly, takes possession of, or title to the Facility (including possession by a receiver or title by foreclosure or deed in lieu of foreclosure), Collateral Agent must assume all of Facility Owner's obligations arising under the Assigned Agreement.

5. Replacement Agreements. Notwithstanding any provision in the Assigned Agreement to the contrary, in the event the Assigned Agreement is rejected or otherwise terminated as a result of any bankruptcy, insolvency, reorganization or similar proceedings affecting the Facility Owner, and if Collateral Agent or its designee, directly or indirectly, takes possession of, or title to, the Facility (including possession by a receiver or title by foreclosure or deed in lieu of foreclosure), Collateral Agent must itself or must cause its designee to promptly enter into a new agreement with Contracting Party for the remainder of the originally scheduled term of the Assigned Agreement, effective as of the date of such rejection or termination, with the same covenants, agreements, terms, provisions and limitations as are contained in the Assigned Agreement, subject to the Collateral Agent or its designee curing all outstanding monetary defaults under the Assigned Agreement and all other non-monetary defaults under the Assigned Agreement which are reasonably susceptible of being cured.

6. Substitute Owner. The Contracting Party acknowledges that in connection with the exercise of possessory remedies following a default under the Financing Documents, the Collateral Agent must cause any purchaser at any foreclosure sale or any assignee or transferee under any instrument of assignment or transfer in lieu of foreclosure to assume all of the interests, rights and obligations of the Facility Owner thereafter arising under the Assigned Agreement as a condition of the sale or transfer; provided, however, that prior to such assumption, if the Contracting Party advises the Collateral Agent that the Contracting Party will require that one or more outstanding defaults under the Assigned Agreement be cured in order to avoid the exercise by the Contracting Party of its right to terminate the Assigned Agreement pursuant to Section 4(c) above, then Collateral Agent, at its option and in its sole discretion, may elect to either: (i) cause such defaults to be cured, in which case, the Assigned Agreement will be assumed by the purchaser, or (ii) not cause such defaults to be cured, in which case, the Assigned Agreement will not be assumed by the purchaser. In case of an assumption of the Assigned Agreement, the assuming party shall be a Permitted Transferee and shall agree in writing to be bound by and to assume the terms and conditions of the Assigned Agreement and any and all obligations to the Contracting Party arising or accruing thereunder from and after the date of such assumption, and, the Contracting Party shall continue to perform its obligations under the Assigned Agreement in favor of the assuming party as if such party had thereafter been named as the "Seller" under the Assigned Agreement.

7. Representations and Warranties.

(a) Facility Owner and Collateral Agent each recognizes and acknowledges that Contracting Party makes no representation or warranty, express or implied, that Facility Owner has any right, title, or interest in the Assigned Agreement or as to the priority of the assignment for security purposes of the Assigned Agreement.

(b) The Contracting Party represents that on the date it provided this Consent that:

(i) No Amendments. [Except as described in Schedule I hereto,] there are no amendments, modifications or supplements (whether by waiver, consent or otherwise) to the Assigned Agreement, either oral or written.

(ii) No Previous Assignments. The Contracting Party affirms that it has no notice of any assignment relating to the right, title and interest of the Facility Owner in, to and under the Assigned Agreement other than the pledge and assignment to the Collateral Agent referred to in Section 1 above.

(iii) No Termination Event: No Disputes. After giving effect to the pledge and assignment referred to in Section 2, and after giving effect to the consent to such pledge and assignment by the Contracting Party, to the knowledge of the Contracting Party: (A) there exists no default or event or condition (a "Termination Event") that would entitle either the Facility Owner or the Contracting Party to terminate the Assigned Agreement or suspend the performance of its obligations under the Assigned Agreement; (B) [except as set forth on Schedule II hereto,] there are no unresolved disputes between the parties under the Assigned Agreement; (C) all amounts due under the Assigned Agreement as of the date hereof have been paid in full[, except as set forth on Schedule II hereto]; and (D) the Assigned Agreement is in full force and effect.

8. Reserved.

9. Payments. The Contracting Party shall make all payments due to the Facility Owner under the Assigned Agreement directly into the account specified on Schedule III hereto, or to such other person or account as shall be specified from time to time by the Collateral Agent to the Contracting Party in writing. All parties hereto agree that each payment by the Contracting Party as specified in the preceding sentence of amounts due to the Facility Owner from the Contracting Party under the Assigned Agreement shall satisfy the Contracting Party's corresponding payment obligation under the Assigned Agreement.

10. Notices. Notice to any party hereto shall be in writing, sent to the respective addresses below, and shall be deemed to be delivered on the earlier of: (a) the date of personal delivery, (b) if sent postage prepaid, registered or certified mail, return receipt requested, or sent by express courier, in each case addressed to such party at the address indicated below (or at such other address as such party may have theretofore specified by written notice delivered in accordance herewith), upon delivery or refusal to accept delivery, or (c) if transmitted by facsimile, the date when sent and facsimile confirmation is received; provided that any facsimile communication shall be followed promptly by a hard copy original thereof by express courier:

The Collateral Agent: [NAME OF COLLATERAL AGENT]

[ ]  
Attn: [ ]  
Telephone No.: [ ]  
Facsimile No.: [ ]

The Contracting Party:

[ ]  
 Attn: [ ]  
 Telephone No.: [ ]  
 Facsimile No.: [ ]

11. Successors and Assigns. This Consent shall be binding upon and shall inure to the benefit of the successors, transferees and assigns of the Contracting Party, and shall inure to the benefit of the Collateral Agent, the other Secured Parties, the Facility Owner and their respective successors, transferees and assigns.

12. Counterparts. This Consent may be executed in one or more counterparts with the same effect as if the signatures thereto and hereto were upon the same instrument.

13. Governing Law. This Consent shall be governed by and construed in accordance with the laws of the State of New York.

14. No Modification. This Consent is neither a modification of nor an amendment to the Assigned Agreement.

15. No Waiver. No term, covenant or condition hereof shall be deemed waived and no breach excused unless such waiver or excuse shall be in writing and signed by the party claimed to have so waived or excused.

16. No Third-Party Beneficiaries. There are no third-party beneficiaries to this Consent.

17. Severability. The invalidity or unenforceability of any provision of this Consent shall not affect the validity or enforceability of any other provision of this Consent, which shall remain in full force and effect.

18. Amendments. This Consent may be modified, amended, or rescinded only by writing expressly referring to this Consent and signed by all parties hereto.

19. Joint Powers Authority. Collateral Agent hereby acknowledges that Contracting Party is organized as a Joint Powers Authority in accordance with the Joint Powers Act of the State of California (Government Code Section 6500 et seq.) pursuant to an agreement executed by the Cities of Davis and Woodland, and the County of Yolo (the "Joint Power Agreement"), that Contracting Party is a public entity separate from its members, and that under the Joint Powers Agreement the members have no liability for any obligations or liabilities of Contracting Party. Collateral Agent agrees that Contracting Party shall solely be responsible for all debts, obligations and liabilities accruing and arising out of the Assigned Agreement, and Collateral Agent agrees that it shall have no rights against, and shall not make any claim, take any actions or assert any remedies against, any of Contracting Party's members, any cities or counties

participating in Contracting Party's community choice aggregation program, or any of Contracting Party's retail customers in connection with the Assigned Agreement.



IN WITNESS WHEREOF, the parties hereto have caused their duly authorized officers to execute and deliver this Consent as of the date first written above.

VALLEY CLEAN ENERGY ALLIANCE

By: \_\_\_\_\_  
Name:  
Title:

[NAME OF COLLATERAL AGENT]  
as Collateral Agent

By: \_\_\_\_\_  
Name:  
Title:

Acknowledged:  
[Seller's corporate entity]

By: \_\_\_\_\_  
Name:  
Title:

Assigned Agreement

Disputes and Amounts Due and Unpaid under the Assigned Agreement  
(Section 7(b)(iii))

Payment Instructions  
(Section 9)

All payments due to the Facility Owner pursuant to the Assigned Agreement shall be made to

[INSERT REVENUE ACCOUNT INFORMATION].

**EXHIBIT F**

**MINIMUM ANNUAL ENERGY PRODUCTION**

<b>Contract Year</b>	<b>Minimum Annual Energy Production (MWh)</b>
1	110,508
2	109,955
3	109,405
4	108,858
5	108,314
6	107,772
7	107,234
8	106,697
9	106,164
10	105,633
11	105,105
12	104,579
13	104,057
14	103,536
15	103,019

*Quantities to be prorated for any partial Contract Year.*

**EXHIBIT G**

**LETTER OF CREDIT *[Under review]***

**[ISSUING BANK] IRREVOCABLE STANDBY LETTER OF CREDIT**

**[DATE OF ISSUANCE]**

[BENEFICIARY] (“Beneficiary”)

[Address]

Attention: [Contact Person]

Re: [ISSUING BANK] Irrevocable Standby Letter of Credit No. \_\_\_\_\_

Ladies and Gentlemen:

We hereby establish in favor of Beneficiary (sometimes alternatively referred to herein as “you”) this Irrevocable Standby Letter of Credit No. \_\_\_\_\_ (the “Letter of Credit”) for the account of Valley Clean Energy Alliance (“Account Parties”), effective immediately and expiring on the date determined as specified in numbered paragraphs 5 and 6 below.

We have been informed that this Letter of Credit is issued pursuant to the terms of that certain *[describe the underlying agreement which requires this LC]*.

1. **Stated Amount.** The maximum amount available for drawing by you under this Letter of Credit shall be *[written dollar amount]* United States Dollars (US\$*[dollar amount]*) (such maximum amount referred to as the “Stated Amount”).

2. **Drawings.** A drawing hereunder may be made by you on any Business Day on or prior to the date this Letter of Credit expires by delivering to [ISSUING BANK], at any time during its business hours on such Business Day, at *[bank address]* (or at such other address as may be designated by written notice delivered to you as contemplated by numbered paragraph 9 hereof), a copy of this Letter of Credit together with (i) a Draw Certificate executed by an authorized person substantially in the form of Attachment A hereto (the “Draw Certificate”), appropriately completed and signed by your authorized officer (signing as such) and (ii) your draft substantially in the form of Attachment B hereto (the “Draft”), appropriately completed and signed by your authorized officer (signed as such). Partial drawings and multiple presentations may be made under this Letter of Credit. Draw Certificates and Drafts under this Letter of Credit may be presented by Beneficiary by means of facsimile or original documents sent by overnight delivery or courier to [ISSUING BANK] at our address set forth above, Attention: \_\_\_\_\_ (or at such other address as may be designated by written notice delivered to you as contemplated by numbered paragraph 9 below). In the event of a presentation by facsimile transmission, you shall contact us at *[INSERT PHONE NUMBER]* and the original of such documents shall be sent to us by overnight mail.

3. **Time and Method for Payment.** We hereby agree to honor a drawing hereunder made in compliance with this Letter of Credit by transferring in immediately available funds the amount specified in the Draft delivered to us in connection with such drawing to such account at such bank in the United States as you may specify in your Draw Certificate. If the Draw Certificate is presented to us at such address by 12:00 noon, [ ] time on any Business Day, payment will be made not later than our close of business on third succeeding business day and if such Draw Certificate is so presented to us after 12:00 noon, [ ] time on any Business Day, payment will be made on the fourth succeeding Business Day. In clarification, we agree to honor the Draw Certificate as specified in the preceding sentences, without regard to the truth or falsity of the assertions made therein.

4. **Non-Conforming Demands.** If a demand for payment made by you hereunder does not, in any instance, conform to the terms and conditions of this Letter of Credit, we shall give you prompt notice that the demand for payment was not effectuated in accordance with the terms and conditions of this Letter of Credit, stating the reasons therefor and that we will upon your instructions hold any documents at your disposal or return the same to you. Upon being notified that the demand for payment was not effectuated in conformity with this Letter of Credit, you may correct any such non-conforming demand.

5. **Cancellation.** This Letter of Credit shall automatically expire at the close of business on the date on which we receive a Cancellation Certificate in the form of Attachment C hereto executed by your authorized officer and sent along with the original of this Letter of Credit and all amendments (if any).

6. **Initial Period and Automatic Rollover.** The initial period of this Letter of Credit shall terminate on [*one year from the issuance date*] (the “**Initial Expiration Date**”). The Letter of Credit shall be automatically extended without amendment for one (1) year periods from the Initial Expiration Date or any future expiration date, unless at least sixty (60) days prior to any such expiration date we send you notice by registered mail or courier at your address first shown (or such other address as may be designated by you as contemplated by numbered paragraph 9) that we elect not to consider this Letter of Credit extended for any such additional one year period.

7. **Business Day.** As used herein, “**Business Day**” shall mean any day on which commercial banks are not authorized or required to close in the State of [New York], and inter-bank payments can be effected on the Fedwire system.

8. **Governing Law.** THIS LETTER OF CREDIT IS GOVERNED BY, AND CONSTRUED IN ACCORDANCE WITH THE LAWS OF THE STATE OF NEW YORK, AND, EXCEPT AS OTHERWISE EXPRESSLY STATED HEREIN, TO THE INTERNATIONAL STANDBY PRACTICES, ICC PUBLICATION NO. 590 (THE “ISP98”), AND IN THE EVENT OF ANY CONFLICT, THE LAWS OF THE STATE OF NEW YORK WILL CONTROL, WITHOUT REGARD TO PRINCIPLES OF CONFLICT OF LAWS.

9. **Notices.** All communications to you in respect of this Letter of Credit shall be in writing and shall be delivered to the address first shown for you above or such other address as may from time to time be designated by you in a written notice to us. All documents to be presented to us hereunder and all other communications to us in respect of this Letter of Credit, which other communications shall be in writing, shall be delivered to the address for us indicated above, or such other address as may from time to time be designated by us in a written notice to you.

10. **Irrevocability.** This Letter of Credit is irrevocable.

11. **Complete Agreement.** This Letter of Credit sets forth in full our undertaking, and such undertaking shall not in any way be modified, amended, amplified or limited by reference to any document, instrument or agreement referred to herein, or in which this Letter of Credit is referred to or to which this Letter of Credit relates, except for the ISP98 and Attachment A, Attachment B and Attachment C hereto and the notices referred to herein and any such reference shall not be deemed to incorporate herein by reference any document, instrument or agreement except as set forth above.

\*

\*

\*

*SINCERELY,*  
[ISSUING BANK]

By: \_\_\_\_\_

Title: \_\_\_\_\_

Address: \_\_\_\_\_



ATTACHMENT A

**FORM OF DRAW CERTIFICATE**

The undersigned hereby certifies to [ISSUING BANK] (“**Issuer**”), with reference to Irrevocable Letter of Credit No. \_\_\_\_\_ (the “**Letter of Credit**”) issued by Issuer in favor of the undersigned (“**Beneficiary**”), as follows:

- (1) The undersigned is the \_\_\_\_\_ of Beneficiary and is duly authorized by Beneficiary to execute and deliver this Certificate on behalf of Beneficiary.
- (2) Beneficiary hereby makes demand against the Letter of Credit by Beneficiary’s presentation of the draft accompanying this Certificate, for payment of \_\_\_\_\_ U.S. dollars (US\$ \_\_\_\_\_), which amount, when aggregated together with any additional amount that has not been drawn under the Letter of Credit, is not in excess of the Stated Amount (as in effect of the date hereof).
- (3) The conditions for a drawing by Beneficiary pursuant to [*describe the draw conditions from the underlying agreement*].
- (4) You are hereby directed to make payment of the requested drawing to: (insert wire instructions)

Beneficiary Name and Address:

By: \_\_\_\_\_  
Title: \_\_\_\_\_  
Date: \_\_\_\_\_

- (5) Capitalized terms used herein and not otherwise defined herein shall have the respective meanings set forth in the Letter of Credit.

[*BENEFICIARY*]

By: \_\_\_\_\_  
Title: \_\_\_\_\_  
Date: \_\_\_\_\_

**ATTACHMENT B**

**DRAWING UNDER IRREVOCABLE LETTER OF CREDIT NO.**

---

Date:

PAY TO: [BENEFICIARY]

U.S.\$ \_\_\_\_\_

FOR VALUE RECEIVED AND CHARGE TO THE ACCOUNT OF LETTER OF CREDIT NO. \_\_\_\_\_.

[BENEFICIARY]

By: \_\_\_\_\_

Title: \_\_\_\_\_

Date: \_\_\_\_\_

**ATTACHMENT C**  
**CANCELLATION CERTIFICATE**

Irrevocable Letter of Credit No. \_\_\_\_\_

The undersigned, being authorized by the undersigned (“**Beneficiary**”), hereby certifies on behalf of Beneficiary to [**ISSUING BANK**] (“**Issuer**”), with reference to Irrevocable Letter of Credit No. \_\_\_\_\_ issued by Issuer to Beneficiary (the “**Letter of Credit**”), that all obligations of [PROJECT ENTITY], an affiliate of the Account Parties, under the [*describe the underlying agreement which requires this LC*] have been fulfilled.

Pursuant to Section 5 thereof, the Letter of Credit shall expire upon Issuer’s receipt of this certificate.

Capitalized terms used herein and not otherwise defined herein shall have the respective meanings set forth in the Letter of Credit.

[**BENEFICIARY**]

By: \_\_\_\_\_

Title: \_\_\_\_\_

Date: \_\_\_\_\_

**EXHIBIT H**  
**EXPECTED ENERGY**

<b>Contract Year</b>	<b>Expected Annual Generation (MWh)</b>
1	134,684
2	134,011
3	133,341
4	132,674
5	132,011
6	131,351
7	130,694
8	130,040
9	129,390
10	128,743
11	128,100
12	127,459
13	126,822
14	126,188
15	125,557

*Quantities to be prorated for any partial Contract Year.*

**EXHIBIT I**

**MILESTONE SCHEDULE**

1	11/30/2018	Execute Interconnection Agreement (Completed)
2	12/31/2019	Procure Major Equipment (Transformers)
3	12/31/2019	Obtain Federal, State, and Local Discretionary Permits (Conditional Use Permit)
4	12/31/2019	Expected Construction Start Date
5	<b>5/31/2020</b>	<b>Guaranteed Construction Start Date</b>
7	3/5/2021	Expected Commercial Operation Date
8	<b>9/24/2021</b>	<b>Guaranteed Commercial Operation Date</b>

**ATTACHMENT A**  
**FORM OF MILESTONE SCHEDULE REPORT**

Within ten (10) Days after the end of each month following the Effective Date until the Commercial Operation Date, Seller shall provide Buyer a monthly written report of its progress toward meeting the Milestone Schedule in **Exhibit I** (the "Milestone Schedule Report"). Each Milestone Schedule Report must include the following items:

1. Summary of activities during the previous calendar month.
2. Forecast of activities scheduled for the current calendar month.
3. Bar chart schedule showing progress on achieving each of the Milestones in **Exhibit I**.
4. An explanation of the reasons for any missed Milestone and a detailed description of Seller's corrective actions to achieve the missed Milestone and all subsequent Milestones by the Guaranteed Commercial Operation Date.
5. List of issues that could potentially impact Seller's ability to achieve the Milestones.
6. Progress and schedule of all agreements, contracts, Permits, approvals, technical studies, financing agreements and major equipment purchase orders showing the start dates, completion dates, and completion percentages.
7. Pictures, in sufficient quantity and of appropriate detail, in order to document construction and startup progress of the Facility, the interconnection into the Transmission System and all other interconnection utility services.

**EXHIBIT J**

**FORM OF COMMERCIAL OPERATION CERTIFICATE**

This certification ("Certification") is delivered to Valley Clean Energy Alliance ("Buyer") by \_\_\_\_\_, an officer of Westlands Solar Park Holdings, LLC ("Seller") who is duly authorized to execute this Certification. Capitalized terms that are not defined in this Certification are defined in the Agreement to which this Certification is a part. Seller hereby certifies and represents to Buyer the following:

(i) Seller has obtained Site Control necessary to operate the Facility in accordance with this Agreement and has provided evidence of such Site Control to Buyer;

(ii) Seller has successfully completed commissioning of the Facility in accordance with applicable manufacturers' specifications;

(iii) Seller has successfully completed all testing required by Prudent Operating Practices or any requirement of law necessary to operate the Facility;

(iv) Seller has satisfied all Interconnection Agreement requirements necessary to deliver Energy to the Delivery Point, such Interconnection Agreements are in full force and effect, and the CAISO has authorized Energy deliveries from the Facility to the Delivery Point;

(v) Seller has obtained all applicable Permits and approvals required to be obtained from any Governmental Authority to operate the Facility in compliance with Applicable Law and this Agreement, and such Permits and approvals are in full force and effect;

(vi) Seller has installed and commissioned at least ninety-five percent (95%) of the Contract Capacity for the Facility;

(vii) Seller has satisfied the Insurance Obligations in Section 6.2 of the Agreement, and Seller has provided evidence of such insurance to Buyer; and

(viii) Seller has delivered to Buyer the Operating Security.

IN WITNESS WHEREOF, the undersigned has executed this Officer's Certificate on behalf of the Company as of the \_\_\_ day of \_\_\_\_\_ 20\_\_.

By: \_\_\_\_\_  
Name: \_\_\_\_\_  
Title: \_\_\_\_\_

## **EXHIBIT K**

### **SELLER'S OTHER FACILITIES**

Seller's other facilities consist of:

- Cluster 8 Projects,
- Cluster 9 Projects, and
- Projects adjacent to Cluster 8 Projects and Cluster 9 Projects with the same Interconnection Point that are developed by Seller or an affiliate thereof.



## VALLEY CLEAN ENERGY ALLIANCE

### Staff Report – Item 20

---

**TO:** Valley Clean Energy Board of Directors

**FROM:** Mitch Sears, Interim General Manager

**SUBJECT:** VCE Strategic Plan Development Process

**DATE:** February 13, 2020

---

#### RECOMMENDATIONS

1. Approve the strategic plan development process and timeline contained in this staff report;
2. Direct the VCE Board Subcommittee and staff to develop a strategic plan for consideration by the full Board by mid-2020.

#### BACKGROUND and ANALYSIS

After several years of feasibility analysis and study, Valley Clean Energy (VCE), formed in December 2016. At its initial meeting, the VCE Board adopted a mission statement to help direct the formation and early operations of the organization. The mission statement was supplemented with the November 2017 adoption of a more detailed vision statement intended to provide both short and longer-term guidance for the organization. At the January 2020 Board meeting staff provided a review of the VCE Vision statement and general progress toward VCE's Vision. During the presentation, staff noted the interest expressed by Board members (and shared by staff and the Community Advisory Committee), to develop a multi-year strategic plan to guide VCE as the organization transitions from early operations.

The Board subcommittee and staff met in mid-January to discuss the potential development of a 3 to 5-year strategic plan for VCE. Following a review of the Vision and Mission statements, the Subcommittee discussed a broad outline for development of a strategic plan. The Board subcommittee and staff agreed that as VCE matures and becomes more established, adoption of a multi-year strategic plan will make VCE more effective in achieving its vision and mission.

Key outcomes of the discussion between the Board subcommittee and staff which have informed the recommendations in this report included:

- The scope of VCE's initial strategic plan should have a tight focus on core policy questions and use the Vision and Mission statements as a starting point
- The development process should be efficient with a goal to develop a draft plan for consideration by the full Board by mid-2020 to help inform the 2020/21 fiscal year budget
- Utilize the subject matter expertise of the Community Advisory Committee, SMUD,

VCE's consultants, and VCE member jurisdictions in the development and review of the plan as it is being drafted

- Solicit input and feedback from members of key customer classes

The purpose of this report is to: (1) provide a summary of early stage activities related to the development and eventual adoption of a strategic plan and (2) propose a plan development process and timeline for consideration by the Board. Board direction will help frame the effort and allow for initiation of the planning process.

### Early Stage Activities

The following early stage activities are included for reference. They are not intended to limit Board discussion but may be useful as a starting point for the strategic plan discussion.

- VCE Vision Statement. <https://valleycleanenergy.org/wp-content/uploads/VCEA-Vision-Statement-11-16-17.pdf>
- VCE Mission Statement. <https://valleycleanenergy.org/wp-content/uploads/Resolution-2016-001-VCEA-Name-Mission.pdf>
- Staff analysis. In early 2019 staff initiated an internal exercise to assess VCE's progress toward stated Board objectives that are captured in the VCE Vision and Mission statements. Staff (including SMUD contract staff), utilized a technique that assesses an organization's strengths, weaknesses, opportunities, and threats (SWOT analysis). The objective of this exercise was to evaluate and calibrate staff work and resources to align with the VCE's guiding statements. The summary of this exercise is included as Attachment 1 and can help inform the Board's discussion regarding development of a strategic plan for VCE.
- Board Subcommittee briefing. The following suggestions were provided to the Board subcommittee in mid-January to help frame the initial discussion on strategic plan development.
  - VCE should maintain a multi-year Strategic Plan, updated at a consistent cadence, and encompassing all key areas of the business.
  - The plan should be the basis for:
    - Annual organization and individual goals
    - Annual budgets
    - Key decisions and priorities
  - The potential cadence of plan and organizational review could be:
    - Strategic Plan update every two years
    - Mission & Vision to be reviewed and updated every three years, or as business changes demand
    - Organization and employee goals updated annually
    - Organization budgets updated annually
- Integrated Resource Plan (IRP). VCE is required to submit an updated IRP to the CPUC on a two-year rolling cycle. The original IRP submitted in 2018 is currently being updated for submission to the CPUC by July 1, 2020. The IRP update process is

underway and can help inform the strategic planning process generally and specifically with regard to the power procurement and portfolio goals/objectives/strategies that would be a central feature of the strategic plan. The current IRP is posted to the VCE website at: <https://valleycleanenergy.org/wp-content/uploads/Reso-2018-021-VCEA-Int-Resrc-Plan-.pdf>

#### Proposed Plan Development Process and Timeline

The following planning process outline and timeline are suggested if the Board’s goal is to adopt a strategic plan by mid-2020. If the Board selects a different goal date for plan consideration/adoption, adjustments to dates and activities can be made. Based on Board direction, staff will develop a detailed project calendar based on the desired plan adoption date. The project calendar would be based on the following key activities and milestones:

Key activities/milestones outline:

- Board direction – February 13, 2020 (current action). Board direction on strategic plan development process and timeline.
- Board Workshop – mid Q1. Conduct Board workshop on strategic plan in late February to establish strategic objectives to guide development of draft plan. This would be a special meeting of the Board organized in a facilitated workshop format.
- Board subcommittee. Direct the Board subcommittee to coordinate with staff to complete development of a working draft plan by late Q1 2020.
- CAC. Activate a CAC Taskgroup to provide input and feedback to staff in the development of the working draft plan (note: CAC Taskgroup formed in late January).
- Stakeholder feedback. Identify members of key customer classes in mid-Q1 2020 and begin draft plan feedback/input collection process in early Q2 2020.
- Draft plan. Present Draft to CAC and Board for review and feedback in mid-Q2 2020.
- Final draft plan. Present final draft to CAC and Board for consideration in late Q2 2020 for adoption by mid-2020 (beginning of FY).

To meet these process milestones the following meetings would be required:

Date	Meeting/Milestone	Purpose
2/13/20	Board	Adopt development process and timeline
Last week of Feb 2020	Board (Special meeting)	Establish strategic objectives to guide development of draft plan
2/27/20	CAC	Process update; Taskgroup direction
3/12/20	Board	Process update
3/26/20	CAC	Process update; Taskgroup report
<b>Late Q1 2020</b>	<b>Milestone</b>	<b>Completion of working draft plan end of Q1 2020</b>
<b>Early Q2 2020</b>	<b>Milestone</b>	<b>Begin collection of stakeholder feedback</b>
4/9/20	Board	Process update; report on working draft
4/23/20	CAC	Process update; Taskgroup report on working draft
<b>Mid Q2 2020</b>	<b>Milestone</b>	<b>Complete initial draft plan</b>
5/14/20	Board	Review/provide direction on draft plan

5/28/20	CAC	Review/provide feedback and recommendation on final draft plan
<b>Late Q2 2020</b>	<b>Milestone</b>	<b>Complete final draft plan</b>
6/11/20	Board	Consider adoption of final plan

Staff believes that this schedule represents an aggressive but achievable goal of adoption of a strategic plan by June 2020.

**ATTACHMENTS**

1. VCE Staff SWOT Analysis Summary – 2019

**VCE Internal SWOT Analysis Summary (March 2019)**

**STRENGTHS**

**Rank from A to Z (A being the strongest strength of VCE)**

- A. Local Control - make decisions quickly, nimbleness
- B. Customer default into VCE
- C. Price Competitive
- D. Leveraging SMUD expertise
- E. Strong customer base that align with mission
- F. Strong alignment with jurisdictions
- G. Location – relative to energy usage/solar applicability (sunny/hot)
- H. Local expertise – legislature, CAC, energy efficiency
- I. Diversity of customer base (Ethnicity and Customer class)

## **WEAKNESSES**

**Rank 1-6 (1 being the most dangerous to VCE's success)**

1. Finances:
  - Lack of Financial Reserves
  - No control over revenues – PG&E rates/PCIA exit fees
  - Difficult to obtain credit rating/financing
2. Lack of brand awareness
3. Lack of full access to our customer data
4. Lack of VCE employees
  - Limited staff
  - Thin structure – no employee/knowledge depth
5. Uncertainty in customers opt out
  - Direct Access
  - General
6. Steep learning curve of electric utility industry for decision makers

## OPPORTUNITIES

Priority 1 – 1 to 2 years (July 2019-June 2021)

Priority 2 – 2 to 3 years (July 2020-June 2022)

### Priority 1:

Cost reduction of LT renewable resources

Design Local customer programs

Adding new member jurisdictions

- Discussions/preparations
- Operational (1-2)

Build reputation and loyalty

Regional efforts

- Partner with regional organizations (i.e. SACOG grant)

Grow electric revenues through electrification within the jurisdictions (i.e. electric vehicles, building electrification) -

- Planning

Increase understanding of electric utility industry for our stakeholders (customers, board)

Coordinate with other jurisdictions on assisting with recovery from disasters

PG&E Bankruptcy – (prepare a separate SWOT analysis)

## **OPPORTUNITIES**

Priority 1 – 1 to 2 years (July 2019-June 2021)

Priority 2 – 2 to 3 years (July 2020-June 2022)

### **Priority 2:**

Offer Local customer programs (as financial resources become available)

Regional efforts

- Improve regional economic vitality (i.e. Reinvest in the community – energy efficiency, EV infrastructure, job creation)

Coordinate with other jurisdictions to obtain state/local funds for energy efficiency programs for our customers (i.e. loans/grants)

Grow electric revenues through electrification with in the jurisdictions (i.e. electric vehicles, building electrification) -

- Implementation

Obtain grants for energy efficiency programs or infrastructure



## THREATS

Uncertainty of annual PG&E rates/PCIA fee

*Regulatory Uncertainty - CPUC*

New legislation

Negative publicity of CCA's

Direct Access – SB 237

PG&E Bankruptcy

Other CCA's adding new member agencies in central valley

**VALLEY CLEAN ENERGY ALLIANCE  
BOARD OF DIRECTORS**

**Staff Report – Item 21**

---

**TO:** VCE Board of Directors

**FROM:** Mitch Sears, Interim General Manager

**SUBJECT:** Valley Clean Energy Policy regarding potential PG&E allocation of GHG-free (Large Hydro and Nuclear) resources to Community Choice Aggregators

**DATE:** February 13, 2020

---

**RECOMMENDATION**

1. Accept the large hydro allocations from PG&E, but not accept the nuclear allocations.

**BACKGROUND**

Valley Clean Energy (VCE) has set a goal for 2020 to serve customers with a minimum 75% GHG-free energy. In 2020, forty-two percent (42%) of VCE's GHG-free energy portfolio are resources that qualify as renewable energy under the state's renewable portfolio standard program (RPS) and 33% are resources that do not qualify under the RPS, but are considered GHG-free. Large hydro and nuclear do not emit any GHG emissions, but don't qualify under the state's RPS.

VCE has procured all of the renewable resources and GHG free (large hydro) that we expect are required to meet this target in 2020. As additional CCAs have started operating with their own GHG-free targets, staff have seen the market for GHG-free resources become tighter and the cost has increased.

PG&E owns or contracts for a number of GHG-free resources (including large hydro and nuclear from Diablo Canyon Power Plant). PG&E has been able to count these resources on its power content label (PCL) to meet its GHG-free targets. Load serving entities (LSEs), on the other hand, have been paying for those same assets through PCIA, yet do not receive any of the GHG-free benefits.

In mid-2019, CCAs approached PG&E to discuss whether PG&E would be agreeable to selling energy from their large hydro facilities<sup>1</sup>. PG&E ultimately refused to make sales in 2019, but subsequently approached CCAs and offered to allocate GHG-free resources (nuclear and large hydro) to CCAs and other eligible load serving entities (LSEs).

---

<sup>1</sup> Large hydro and nuclear resources count as GHG-free on the power content label (PCL), and investor-owned utilities (IOUs) have been benefiting from counting those resources to meet their GHG-free targets. LSEs, on the other hand, have been paying for those same assets through PCIA, yet do not receive any of the GHG-free benefits through the PCL.

There is a separate, similar effort occurring in the Power Charge Indifference Adjustment (PCIA) Phase 2 Working Group 3 (WG 3) that is focusing on the allocation of GHG-free energy, among other things. Since the PCIA effort is expected to take effect in 2021, the allocations addressed in this staff report are considered an interim approach for 2020 only until PCIA decisions are finalized. Both the PCIA proposal and the interim allocation proposal are works in progress and subject to change pending final CPUC approval.

The purpose of this report is to provide background and information for the CAC to discuss staff's recommendation to accept VCE's share of the large hydro allocation but not the nuclear allocation under the interim proposal for 2020 only.

### Interim Proposal by PG&E

The key elements of the interim proposal include:

- Limited in time to 2020
- Limited in the resources to which it applies:
  - In-state
  - Large hydroelectric
  - Nuclear
- Only available to retail suppliers whose customers pay PCIA with large hydroelectric and nuclear in their PCIA vintage
- Requires active agreement between retail suppliers to offer and to take generation
- Requires that the CPUC approve a mechanism for the allocation of such generation
- No payment required

There is no obligation to accept this allocation of GHG-free energy. An LSE can choose to accept neither resource pool, one or the other, or both.

The PCIA is a non-bypassable charge set annually by the CPUC. The interim proposal and allocation mechanism, and whether VCE accepts an allocation, has no impact on PCIA charges. Regardless of what happens with the allocation mechanism, all customers, VCE customers included, pay for, and will continue to pay for PG&E large hydroelectric and nuclear generation costs through the PCIA.

A link to the PG&E Advice Letter which details the interim proposal is included in the reference section at the end of this staff report.

### **ANALYSIS**

Under the interim proposal, PG&E will allocate to each eligible LSE its load share of large hydro (hydro pool) and/or nuclear resources (nuclear pool) based on an LSE's election. VCE accounts for approximately 1% of PG&E's share. Staff estimates that the allocation PG&E offers to VCE may contain the following:

- 90 GWh of large hydroelectric power
- 140 GWh of nuclear power

The volume that each LSE receives will ultimately depend on the volume of electricity generated by each resource pool in 2020 and the proportion of PG&E’s load served by the LSE. PG&E has identified public historical production data for each resource pool and will provide ongoing allocation amounts for LSEs to forecast and keep track of allocation amounts.

VCE is eligible for this allocation as an LSE (as defined in the CAISO Tariff) that: (1) has forecasted load identified in PG&E’s Energy Resource Recovery Account (ERRA) Forecast Application (ERRA Forecast Departed Load) for the calendar year in which the Allocation Amount is accepted; and (2) serves customers who pay the PCIA departing load charges for the above market costs of Resources.

On December 2, 2019, PG&E filed a Tier 3 Advice Letter and requested that the CPUC issue a final resolution by February 1, 2020. The interim proposal will only become effective upon CPUC approval of this Advice Letter and will remain in effect until the earlier of the effective date of a CPUC action on the PCIA Proposal Rulemaking (R.1706-026) ordering an alternative methodology (PCIA Decision) and December 31, 2020. In practice, this means through 2020.

Once the Advice Letter is approved and PG&E offers the allocation, the LSE has 30 days to accept its allocation of hydro and/or nuclear pool(s). Any unallocated amounts will revert back to PG&E to use or dispose as it sees fit pursuant to applicable law.

In exchange for the allocation by PG&E, the receiving LSE “will waive their ability to make petitions, arguments or filings at the CPUC or at the California State Legislature regarding PG&E not offering any allocation, sale or transfer of Carbon Free Energy or attributes for the period that the eligible LSE accepts the offer. Neither PG&E nor the eligible LSEs will be required to post credit or collateral.”

PG&E will provide each LSE with an annual attestation confirming actual year-end totals of generation from the Resource Pool(s) and notify the California Energy Commission of the sale of the Product for purposes of PCL reporting.

**FISCAL IMPACT**

VCE has already procured GHG-free resources for 2020. Accepting either allocation (hydro or nuclear) results in a savings to VCE, and not any additional costs. Assuming a conservative estimate of \$6/MWh for GHG-free resources based on recent market transactions, the table below estimates that the savings from the large hydro allocation will be \$540,000 and the nuclear allocation will be \$840,000.

**Scenario Allocated GHG- Free Resources**

Scenario	Total Allocated GHG Free Resources (Large Hydro + Nuclear)	Accepted GHG Free Resources	Potential Savings
A (Hydro + Nuclear)	230 GWh	230	\$1,380,00
B (Nuclear only)	140 GWh	140	\$840,000
C (Hydro only)	90 GWh	90	\$540,000

Scenarios to Consider

By accepting an allocation of carbon free energy from PG&E, VCE will decrease the volume of previously contracted GHG-free energy we need in 2020 to meet it's 75% GHG-free target. Staff have prepared three scenarios to consider

- Scenario A - PG&E offers carbon-free allocations up to VCE's load share percentage (1% of PG&E load), amounting to 230 GWh. VCE accepts all carbon-free allocations – both hydro pool and nuclear pool. Consider option to sell off nuclear allocation if buyers are available.
- Scenario B - PG&E offers carbon-free allocations up to VCE's load share percentage (1% of PG&E load), amounting to 140 GWh. VCE accepts the nuclear carbon-free allocations.
- Scenario C - PG&E offers carbon-free allocations up to VCE's load share percentage (1% of PG&E load), amounting to 90 GWh. VCE accepts the hydro pool carbon-free allocations.
- Scenario D - VCE rejects allocations from both resource pools.

Some CCA's are considering acceptance of both allocations with the intent to resell the nuclear allocation to capture cost savings but avoiding

#### Community Advisory Committee Recommendation

The Community Advisory Committee (CAC), considered the issues contained in this staff report at a special meeting on February 5<sup>th</sup>. The CAC engaged in a detailed discussion about the advantages and drawbacks of accepting the allocations. The CAC voted 4-2 to support the staff recommendation to accept large hydro allocations from PG&E, but not accept the nuclear allocations. The CAC's support was subject to confirmation that: 1) VCE would only be getting the attributes and not the energy and 2) clarification and interpretation of meaning of the statement that the LSE (VCE) "will waive their ability to make petitions, arguments or filings at the CPUC or at the California State Legislature regarding PG&E not offering any allocation, sale or transfer of Carbon Free Energy or attributes for the period that the eligible LSE accepts the offer".

Staff's understanding is that the allocations are for the GHG free attributes only and that any restrictions are limited to issues associated with the large hydro and nuclear allocations for 2020. Since these questions were raised the day before the writing of this staff report, staff is following up on these questions and will provide confirmation as part of the Board presentation on February 13<sup>th</sup>. Note: the no votes by CAC members centered on different issues; one with lack of information on the underlying motivation to offer the allocations, and the second on an interest in accepting both allocations for the express purpose of using any cost savings to help fund VCE's priority local programs/projects.

#### **RECOMMENDATION**

Staff recommends that the Board adopt Scenario C (large hydro only). This is a challenging policy question due to the fact that regardless of VCE's decision: (1) the Diablo nuclear plant will continue to operate until 2024/25, and (2) VCE customers will pay for the GHG attributes from the plant through the PCIA charge. In addition, the potential savings would help VCE advance its policy goals. These factors are balanced against the potential reputational risk associated with taking VCE's nuclear allocation. Note: other CCA's located in PG&E's service territory have both accepted and rejected the

nuclear allocation with decisions based on local factors. Links to analysis from several other CCA's and PG&E's advice letter are included as references at the end of this report.

Staff believes that:

- The potential reputational risk from accepting the nuclear allocation as part of our GHG-free target is greater than the potential savings for accepting this allocation.
- Although there would be monetary savings in 2020 from accepting the nuclear allocation, VCE's power procurement budget was balanced for 2020 without this additional funding.
- Generally nuclear is not considered a clean fuel source due to risks associated with spent fuel and practical long-term disposal options.

Based on these factors, staff believes that VCE is better served by accepting the hydro allocations for 2020 but not the nuclear allocations.

#### Reference Materials

EBCE:

- <https://ebce.org/wp-content/uploads/Item-16-Carbon-Free-Allocation-Informational-Item-1.pdf>
- <https://ebce.org/wp-content/uploads/Item-14-Carbon-Free-Allocation-Questions-.pdf>

PCE: <https://www.peninsulacleanenergy.com/wp-content/uploads/2020/01/2020-01-23-Peninsula-Clean-Energy-Board-agenda-packet-1.pdf>

PG&E Advice Letter: [https://www.pge.com/tariffs/assets/pdf/adviceletter/ELEC\\_5705-E.pdf](https://www.pge.com/tariffs/assets/pdf/adviceletter/ELEC_5705-E.pdf)

**VALLEY CLEAN ENERGY ALLIANCE**

**Staff Report – Item 23**

---

**TO:** VCE Board of Directors

**FROM:** Mitch Sears, Interim General Manager  
Jim Parks, Director of Customer Care and Marketing

**SUBJECT:** SACOG Grant Update

**DATE:** February 13, 2020

---

**REQUESTED ACTION**

Informational item. No action requested.

**BACKGROUND**

VCE joined with the cities of Davis and Woodland and Yolo County to apply for a \$2.9 million grant from the Sacramento Council of Governments (SACOG). The purpose of the grant is to install electric vehicle charging infrastructure in Yolo County. The proposal was successful, and the grant was approved by the SACOG board of directors on December 20, 2018. The project is titled Electrify Yolo.

Since that time the Electrify Yolo team, made up of VCE member jurisdiction staff, has worked to facilitate a fund swap between SACOG and the City of Davis, and to further develop the project.

**UPDATE**

The fund swap was approved by SACOG in late December and the Davis city council approved the agreement at the end of January. Now that funding is in place, the Electrify Yolo team is working to implement the project. Staff will be providing a Board presentation at the February 13<sup>th</sup> meeting that will provide an update on those activities.